

# Protecting Electricity Networks from Natural Hazards



Organization for Security and  
Co-operation in Europe

## **Disclaimer**

The materials in this publication are for ease of reference only. The views, findings, interpretations and conclusions expressed herein are those of the authors and contributors and do not necessarily reflect the views or policies of the OSCE and its participating States. The OSCE does not accept any liability for any damage or loss which may arise out of the reliance on information contained in this publication.

© 2016 Organization for Security and Co-operation in Europe (OSCE); [www.osce.org](http://www.osce.org)

All rights reserved. No part of this publication may be reproduced, stored in a retrieval system, or transmitted in any form or by any means – electronic, mechanical, photocopying, recording, or otherwise without prior written permission of the publishers. This restriction does not apply to making digital or hard copies of this publication for internal use within the OSCE and for personal or educational use when for non-profit and non-commercial purposes, providing that copies bear the above mentioned notice and a following citation:

Protecting Electricity Networks from Natural Hazards.  
2016 © OSCE

Design & Layout: red hot 'n' cool  
Cover photo: © Mohamed Kasim Naufal | Dreamstime.com  
Language Editor: Kathryn Platzer

The project received financial support from the following participating States: Republic of Austria, Federal Republic of Germany, Slovak Republic and United States of America.

Office of the Co-ordinator of OSCE Economic  
and Environmental Activities  
Wallnerstrasse 6  
A.1010 Vienna, Austria  
Tel: +43 1 514 360 E-Mail: [pm-ceed@osce.com](mailto:pm-ceed@osce.com)

# Protecting Electricity Networks from Natural Hazards

# Acknowledgements

The Handbook on Protecting Electricity Networks from Natural Disasters is the result of a collaborative effort of the colleagues mentioned below from inside and outside the OSCE.

The production of this publication was conceived by the Co-ordinator of OSCE Economic and Environmental activities, supervised by Desiree Schweitzer, Deputy Co-ordinator/ Head, Environmental Activities, OCEEA, and managed by Daniel Kroos Senior Programme Officer for Energy Security. Special thanks go to the OCEEA colleagues who supported the project in its different phases: Cyril Leroy in its inception, Snezhana Shtonova and Petronela Durekova of the OCEEA in the production phase.

The production of this publication was managed by the Office of the Co-ordinator of OSCE Economic and Environmental activities (OCEEA), under the direction of Desiree Schweitzer, Deputy Co-ordinator/ Head, Environmental Activities, with responsibility for energy security and Daniel Kroos- the current- and Cyril Leroy -the former- Senior Programme Officer for Energy Security, as Project Managers. Special thanks go to the OCEEA colleagues who supported the project in its different phases: Snezhana Shtonova and Petronela Durekova.

The OCEEA is deeply grateful to Nadejda Komendantova, Senior Research Scholar at the ETH Zurich and coordinator of Governance in Transition Theme at International Institute for Applied Systems Analysis (IIASA), lead consultant and editor of the Handbook for her commitment and substantive contributions, bringing this publication to fruition.

Special thanks go to all contributors to this publication:

Eric Andreini (RTE), Brigitte Baltasar (Willis Re), Terry Boston (GO15), Kanat Botbaev (Energy Charter Secretariat), Jed Cohen (Virginia Tech), Christine Eismann (Federal Office of Civil Protection and Disaster Assistance), Torolf Hamm (Willis Re), Alexander Garcia-Aristizabal (AMRA), Matjaž Keršnik (Electro Ljubljana), Martin König (Environment Energy Agency)\*, Wolfgang Kröger (Swiss Federal Institute of Technology Zurich), Marc Lehmann (Willis Re), Iryna De Meyer (Energy Charter Secretariat), Hubert Lemmens (GO15), Klaus Moeltner (Virginia Tech), Milka Mumovic (Energy Community Secretariat), Johannes Reichl (Energy Institute at the Johannes Kepler University), Giovanni Sansavini (Swiss Federal Institute of Technology Zurich), Michael Schmidthaler (Energy Institute at the Johannes Kepler University), Alain Steven (GO15), Lubomir Tomik (CESys), Christopher Zobel (Virginia Tech), Friedemann Wenzel (Karlsruhe Institute of Technology).

---

\* Martin König passed away shortly after authoring his contribution. He was a leading expert in climate change adaptation research and a valued colleague with a distinguished publication record on disaster risk reduction.

# Table of contents

Acknowledgements	2
Foreword	5
Executive summary: From science to policy	7
<b>Chapter 1: Principles of disaster risk reduction</b>	<b>11</b>
1.1. Key elements of risk assessment of electric power networks	11
1.2. Multi-risk assessment in critical infrastructure: the case of electricity transmission networks	25
1.3. Multi-hazard perspectives for power network resilience	29
1.4. Electricity supply security, service valuation, and public perception of energy infrastructure	34
1.5. Transition to a renewables-based power system: why public participation has an important role to play in power grid planning	43
1.6. Safety culture in high risk industry and main principles	48
1.7. Electricity grid resilience under climate change	51
<b>Chapter 2: Case studies</b>	<b>59</b>
2.1. Case studies of three blackouts: 2003 in Italy and Switzerland as well as in Sweden and Denmark, and of 2006 in Germany	59
2.2. Slovenia: Icing in 2014	63
2.3. Southeastern Europe: Floods in 2014	66
2.4. France: Storms in 1999.	69
2.5. China: Earthquake of 2008	71
<b>Chapter 3: Good practices from private and public sector stakeholders</b>	<b>77</b>
3.1. National Civil Protection	77
3.2. GO15	81
3.3. Insurance industry	85
3.4. Energy security: International organizations	92
Figures	98
Authors and organisations	100



# Foreword

I am pleased to present the Handbook on Protecting Electricity Networks from Natural Hazards. The Handbook offers a comprehensive view of concepts and tools in risk mitigation and risk management, as well as a number of local and regional case studies. It aims to support participating States in protecting critical electrical energy infrastructure from natural hazards through increased threat resilience.

Energy security provides the backbone of industrialized societies and economies. Without uninterrupted power supplies, modern economies could not function. As regional economies grow increasingly interconnected, they also become increasingly vulnerable to regional and supra-regional blackouts. The consequences to the economy and the environment can be severe. Blackouts lasting several days can lead to the breakdown of communication, transport, and district heating systems. They can threaten water supplies and sanitary systems. They can bring trade and production processes to a halt and oblige hospitals to work using emergency power supplies. In short, power blackouts can threaten the stability of entire regions. Recent data suggest that climate change leads to an increased number of extreme weather events, thus increasing the likelihood of severe impacts on electricity infrastructure that lead to blackouts.

The protection of electricity networks from natural disasters is a highly relevant issue for the Organization for Security and Co-operation in Europe (OSCE) whose 57 participating States and 11 Partners for Co-operation include some of the largest producers and consumers of energy as well as many strategic transit countries. In December 2013 OSCE participating States adopted a Ministerial Council Decision on Protecting Energy Networks from Natural and Man-Made Disasters [MC.DEC/6/13]. Under this they committed to cooperation and improved consideration of all necessary measures to increase the protection of energy networks from natural and man-made disasters. In the decision, the Office of the Coordinator of Economic and Environmental Activities (OCEEA) was tasked to facilitate the exchange of good practices, technological innovations, and information sharing on how to effectively prepare for threats to energy networks from natural disasters, with sole emphasis on electricity networks.

In implementing MC.DEC/6/13 the OCEEA in 2014 organized an Expert Workshop on Sharing Best Practices to Protect Electricity Networks from Natural Disasters with



**Halil Yurdakul Yigitguden, Co-ordinator of OSCE Economic and Environmental Activities**

key stakeholders from the public and private sector and academia, followed by the preparation of this Handbook on Protecting Electricity Networks from Natural Hazards, which is largely based on the recommendations of the workshop.

The purpose of this Handbook is to raise awareness and build capacity among key stakeholders, namely, transmission operators, relevant ministries, national regulators, NGOs, and the private sector, to exchange best practices and knowledge on effective risk mitigation and management strategies before and after national and regional electricity networks are affected by natural disasters. The Handbook provides a unique view on the subject by including contributions from all key stakeholders mentioned above. Mitigating and managing risks of blackouts in electricity transmission grids remains a complex challenge to all key stakeholders. Effective cooperation among OSCE participating States can be a powerful tool that helps us to make critical energy infrastructure more resilient to natural hazards.

Yours truly,

A handwritten signature in blue ink, appearing to read 'Yigitguden', with a stylized flourish at the end.

**Halil Yurdakul Yigitguden**  
Co-ordinator of OSCE Economic and Environmental Activities





# Executive summary:

## From science to policy

Security of energy supply requires sufficient electricity to be generated to cover energy demand and its reliable transmission of electrical power from generation to consumption centers. Electricity transmission infrastructure is vital for functioning of modern economies and is, thus, regarded as a “critical” infrastructure. As industry, communication systems, transportation, and several other sectors depend on the secure and reliable supply of electricity, failures in electricity delivery can result in significant economic costs and the collapse of modern economic and social life. To protect electricity transmission and distribution grids from multiple risks, the functionality, continuity, and integrity of electricity transmission networks must be ensured; this includes assessment, mitigation, and effective management of blackout risks. Creating a resilient electricity transmission system will reduce the likelihood of damage to critical infrastructure, limit negative effects on national and regional economies, and shorten time needed to recover supply.

Today, the task of protecting electricity transmission systems has become a greater challenge than ever before: during the last decade the number of blackouts has grown steadily, as have their respective impacts, affecting an increasingly large number of people in developing, transition, and developed countries. The number of major blackout events – classified as disasters when 1000 people or more people are affected for at least 1000 hours or 1 million people are affected for at least one hour – has increased. These major blackouts have also grown in terms of their intensity and impact, both inside and outside the area of the Organization for Security and Co-operation in Europe (OSCE).<sup>1</sup>

Mitigating and managing blackout risks in electricity trans-

mission grids is a challenging task because of the complexity of electricity transmission system and the number of components involved, such as generators, transformers, and high- and low-voltage transmission and distribution lines. All these components are interdependent and include a large number of elements, such as interconnectors, edges, and nodes. Each element can become vulnerable to existing and newly emerging risks such as natural hazards, terrorist and cyber-attacks, or human failures. Electricity transmission grids can also incur multiple or multi-risks, including their conjoint and cascading effects, or systemic risks. Natural hazards like earthquakes, storms, floods, and heatwaves, are among the major causes of electricity blackouts. These can damage or destroy electricity transmission infrastructure or reduce its transmission capacities. Hydro-meteorological disasters or extreme weather conditions, such as storms and floods, are the most frequent events. According to the available scientific evidence, climate change impacts will be more frequent and intense in the near to medium term.

The OSCE is the world’s largest regional security organization and, among other activities, focuses on critical energy infrastructure, including electricity transmission, which is an emerging and important security-related topic. In 2013 the OSCE Ministerial Council in Kiev adopted a decision on “Protecting Energy Networks from Natural and Man-made Disasters” (MC.DEC/6/13). In line with this decision, the Office of the Co-ordinator of Economic and Environmental Activities (OCEEA) of the OSCE prepared this Handbook on the Protection of Electricity Networks from Natural Hazards, based on an expert workshop on the same topic held in Vienna, Austria, on 2 July 2014. The objective of the workshop, “Protection of Electricity Networks from Natural Hazards” and of the present handbook was to contribute to enhancing the capacities of OSCE participating States to fulfill their commitments with regard to MC.DEC/6/13 by raising awareness of, and facilitating dialogue and knowledge sharing on, the protection of electricity networks from natural disasters. The expert workshop brought together government officials from participating States as well as representatives of inter-

<sup>1</sup> For instance, a major blackout in the USA and Canada took place on 9 November 1965, affecting 30 million people. Subsequent blackouts in Thailand on 18 March 1978 and in Brazil on 11 March 1999 affected 40 million people and a record number of 97 million people, respectively. The largest number of major blackouts have occurred post-2001. On 2 January 2001, 230 million people were affected in India. In the same year, 55 million people were affected by a major blackout in the USA and Canada. In 2001, 55 million people were affected in Italy and Switzerland. In 2005 a major blackout hit Java, Indonesia, affecting 100 million people. Five major blackouts occurred during the last six years: in 2009 in Brazil and Paraguay affecting 87 million people, in 2012 in India affecting 620 million, in 2014 in Bangladesh affecting 150 million, in 2015 in Pakistan affecting 140 million, and in 2016 in Sri Lanka affecting 21 million people.

national organizations and institutions, specialized agencies, the energy industry (including transmission system operators), and academia. The scope of the workshop was limited to protection of electricity networks from natural disasters: geophysical (earthquakes, volcanoes, landslides); hydrological (floods, landslides, avalanches); meteorological (storms); and climatological (extreme temperatures, droughts). The workshop provided insights into good practices and brought together knowledge and experience from different countries and stakeholders across the entire process of protecting electricity networks from natural disasters. These included risk assessment (to identify threats, assess vulnerabilities, identify and quantify potential losses); risk preparedness, prevention, and mitigation (including technical and physical protection measures and planning, as well as organizational measures, capacity building, early warning, and internal controls); risk management (disaster management); reconditioning (back-up supply and provisional repair); and risk recovery (reconstruction, financing, repairing, and restoring).

This handbook integrates recommendations developed during the Vienna workshop, such as the need for intensified cooperation among different groups of stakeholders, enhancement of risk awareness, and the stronger involvement of civil society. In particular, the workshop developed the recommendation to pursue a comprehensive approach to the protection of electricity transmission networks. This entails cooperation among all key stakeholders: national governments, regional and non-governmental organizations, the business community, academia, development agencies, and financial institutions.

The novelty of this handbook lies in the selection of contributions it contains, which allow the reader to gain a holistic view of efforts to protect electricity transmission networks across the entire disaster risk reduction cycle. It also brings together the views and perspectives of stakeholders from different sectors, such as transmission systems operators, insurance companies, national civil protection authorities, non-governmental organizations, international and multi-lateral organizations, and academia. The handbook does not aim to be a “step-by-step” manual. Its main goal is to collate information on a variety of practices available to stakeholders from different sectors to facilitate the exchange of information and to provide a “snapshot” of the existing heterogeneity of voices, experiences, and practices.

The handbook has been designed as a guide for practitioners such as representatives of public and private stakeholders and also academia and civil society, to enable them to benefit from the wide range of contributions presented in this handbook. It will serve as a reference for government policymakers, state authorities, and regulators in charge of protecting energy networks, as well as public and private owners and operators of electricity networks. The handbook encourages infrastructure owners and operators, emergency responders, regulators, government stakeholders, and industry groups to work together more closely to improve the resilience of critical electricity transmission infrastructure. With this in mind, the handbook shares advice and existing practices available to different stakeholders to continuously improve the resilience of electricity transmission infrastructure to natural hazards.





## Chapter 1

# Principles of disaster risk reduction

This chapter deals with key concepts of risk assessment, mitigation, and management of natural hazards affecting electricity transmission networks. The chapter aims to provide a holistic and multi-risk view on the issue of protection of electricity transmission networks. It therefore not only includes natural hazards but also discusses other relevant hazards and the systemic risks connected with different types of technologies of electricity generation. The chapter also discusses the relevance of human failures in a multi-risk perspective and the overall resilience of electricity transmission systems. Covering the entire disaster risk reduction cycle, it addresses the topic of risk governance and human factors affecting the implementation of risk management and mitigation measures. Risk governance also includes public and social acceptance of deployment of additional electricity transmission grids and should incorporate key concepts of an effective corporate safety culture.

Contributions to this chapter comprise an overview of key elements of risk assessment by ETH Zurich, Switzerland, and key elements of multi-risk assessment by AMRA, Italy. The chapter also includes a multi-hazard perspective of electricity transmission network resilience by the Karlsruhe Institute of Technology, Germany, and Virginia Tech, USA. Contributions on risk governance then follow, including: socioeconomic impacts of blackouts by the Johannes Kepler University, Austria and Virginia Tech, USA; participatory governance to enhance electricity transmission systems resilience by Germanwatch, Germany; and safety culture by CESys, Slovakia. The chapter ends with a contribution by the Environment Agency of Austria on the vulnerability of electricity transmission system to climate impacts.

### 1.1. Key elements of risk assessment of electric power networks

**Wolfgang Kröger and Giovanni Sansavini**  
Swiss Federal Institute of Technology (ETH),  
Zurich, Switzerland

The highly meshed European transmission system is grouped into five synchronous areas and managed by a network of 41 transmission system operators (TSOs) from 34 countries across Europe (Figure 1).

Current major energy political and organizational changes, namely, the targeted increase in the share of renewable energy resources (RES) and the European unbundled International Energy Market, are posing the following challenges to transmission systems: (a) the integration of intermittent asynchronous energy sources, which are usually abundant in scarcely populated areas and often available during low demand periods (e.g., night hours) thus requiring both massive power transfers over long distances and peak smoothing strategies; (b) close-to-real-time monitoring is commonly performed via unprotected communication channels and safety checking which entails ubiquitous use of commercial IT hardware and software; (c) short-term trading entails both SCADA data and cross-border power exchange.

The synchronous European transmission system is managed according to the instructions in the UCTE (now ENTSO-E) Operational Handbook (OH); this is a comprehensive collection of operational principles, technical standards, and recommendations for TSOs in continental Europe which aim to support safe operations of the interconnected, synchronous grid and to ensure interoperability among all TSOs, with each partner being responsible for its own network. In particular, TSOs are not allowed to interfere with market forces unless system safety is at stake.

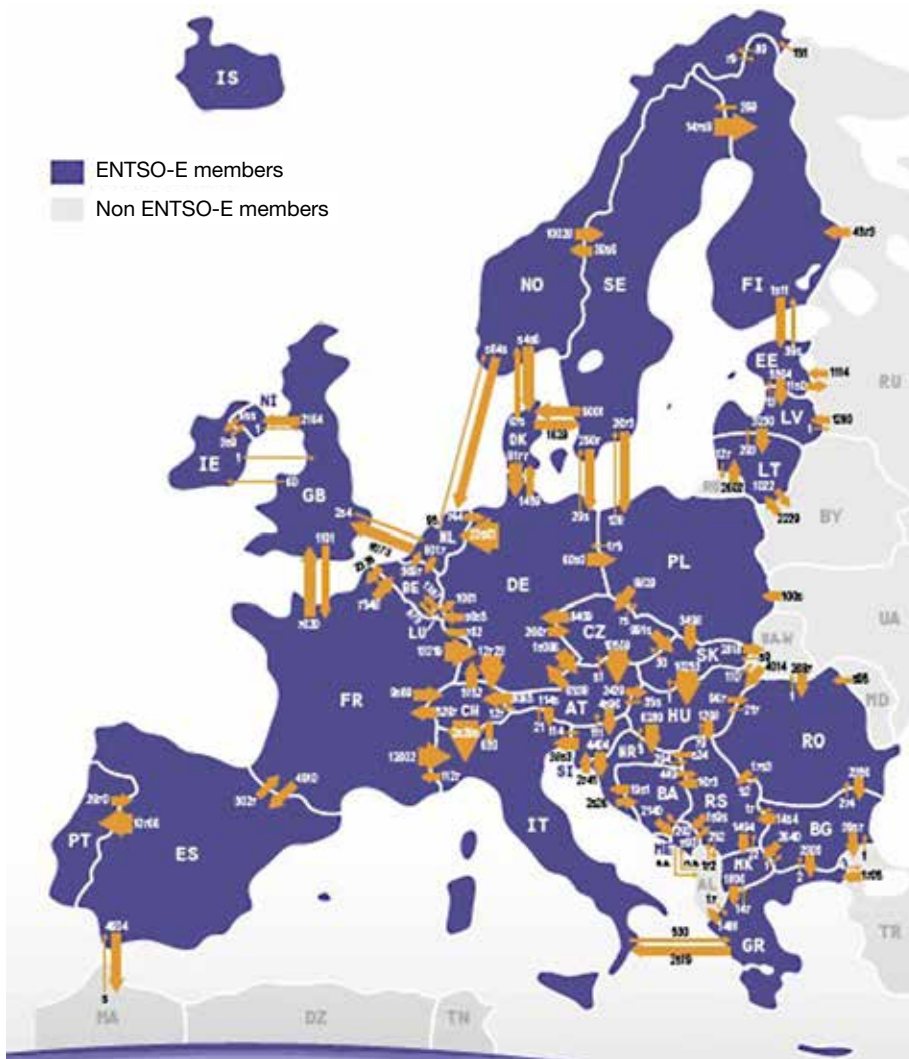

**Key figures (2012):**

- 5 synchronous areas
- Network of 41 TSOs from 34 countries
- Serving 534 million citizens – 3'300 TWh consumption, 13% cross-border
- 305'000 km of transmission lines

**Main goals:**

- Security of supply, reliable operation
- Efficient and competitive market
- Optimal management and sound technical evolution of the system

Figure 1. The synchronous European Transmission System.

Source: ENTSO-E Memo 2012

Power system reliability as a concretization of the concept of “safety” is defined as the ability to:

- Ensure normal system operation;
- Limit the number of incidents and avoid major incidents;
- Limit the consequences of major incidents whenever they occur.

To guarantee system reliability, protection must be provided against three main phenomena: a) cascade tripping; b) voltage collapse or frequency collapse; c) loss of synchronism.

To ensure “security” against sudden disturbances in operational planning and real-time operations, the N – 1 principle is of major importance in preventing unplanned events that produce abnormal system conditions. Such “disturbances” may follow an unexpected failure or outage of a system component or may also include multiple components, related by situations, leading to simultaneous component outages, all defined as “contingency.” According to the N – 1 principle, elements in operation after the failure of a single element of the interconnected network must be capable of accom-

modating the change of flows caused by the single failure; a cascade of trippings or the loss of a significant amount of consumption should be avoided. N – 1 security should be monitored at all times by the TSOs for their own systems and some defined parts of adjacent systems. After a contingency, each TSO is supposed to return to N – 1 compliant conditions as soon as possible.

There are three types of contingency: “normal,” comprising the loss of a single element such as a line; “exceptional,” comprising elements such as two lines at the same tower over a long distance; and “out-of-range,” comprising losses of a very small likelihood. Lists of contingencies are developed by TSOs and need to be taken into account for N – 1 security calculations. Thus, N – 1 can be ranked as a best-practice deterministic criterion complemented by a probabilistic approach to exclude contingencies from ex ante simulations (see Figure 2 for summary).

The assessment of power system security can be broadly divided into static and dynamic security. Static security assessment is performed through the N -1 principle and includes: i) computation of the available transfer capability of trans-

**One goal**  
"No cascading with impact outside my border"

**Two obligations**

- 1 – Obligation for each TSO to monitor the consequences of the events defined in its contingency list (= normal + exceptional contingencies) and warns its neighbours when its own system is at risk at any operational planning stage and in real time
- 2 – Mandatory coordination by bi-multilateral, even regional actions to better assess the consequences of any domestic TSO's decision

**Three behaviours**

- 1 – "Be aware of the risks", even if not sufficiently covered by remedial action due to too high costs (potential emergency situations)
- 2 – "Best efforts" to set-up remedial actions, that is not always possible or sufficiently efficient by one single TSO to cover exceptional contingencies
- 3 – Be aware of impacts of domestic operational decisions (switching, redispatching, outage planning, capacity assessment) on neighboring systems

**Risk assessment: a concern**  
Each TSO is only responsible for the operation of its own network. But it is required to inform relevant neighbors in case it assumes some risks to come from outside or to come from inside to be propagated abroad.

**Inter-TSO coordination**  
Bilateral, multi-lateral or regional coordination is requested to assess risks, to ensure efficiency of operational decisions and remedial actions.

Figure 2. Summary of the N – 1 principle according to ENTSO-E Operational Handbook

Source: ENTSO-E Operational Handbook

mission links and identification of network congestion bottlenecks for pre-contingency states; and ii) the evaluation of bus voltages and line power flow limits for post-contingency states. The main concern of static security assessment is cascade tripping.

Static security assessment assumes that every transition from the pre- to post-contingency state takes place without any instability phenomena arising. Dynamic security assessment evaluates the stability and quality of the transition from the pre- to post-contingency state. Its main concern is voltage collapse, frequency collapse, and loss of synchronism. The main components of the dynamic security assessment are described in CIGRE Report No. 325.

Security management has recently been challenged by i) the increase in the share of renewable energy resources; ii) the unbundled International Energy Market; and iii) the increased participation of an active demand side. Indeed, the interplay among these elements changes the system operating conditions by affecting the generation output and the demand input, and this forces the system operator to continuously monitor and steer the system state within safety bounds.

## 1. Scope, goals and measures of risk analysis; illustration of results; contrasting terms

There is no commonly agreed definition of risk. To express risk in risk analysis there is the traditional interpretation that

risk is a property of the system being analyzed and that it comprises the probability of whether or not undesired events will occur and an indication of how severe their consequences will be. A more recent interpretation claims that there are no inherent probabilities describing the system, and whether events occur or not and how severe their consequences might be is uncertain, being dependent on the state of knowledge (Hokstad 2012).

Regarding the operation of a power system, we accept the definition of a risk assessed by the product "Event probability x Expected loss." The loss might be defined either by a financial loss or, more commonly for a power system, in terms of a potential power cut or energy loss. The following formula quantified the risk  $R_i$  associated to the event i:

$$R_i = P_i * S_i \text{ where } S_i = G_i * D_i$$

Where  $P_i$  is the likelihood of the event i for a given unit of time (namely, an hour),  $S_i$  is the associated severity, expressed in terms of non-feeding energy (the severity is the multiplication of the gravity  $G_i$  and the restitution time  $D_i$ ).

As the above definition of the risk is based on the non-feeding energy, it is also possible to estimate the cost  $C_i$  of this risk:

$$C_i = R_i * \text{€}$$

The results of a risk analysis can be illustrated in a risk register, that is, a table with undesired events in separate rows

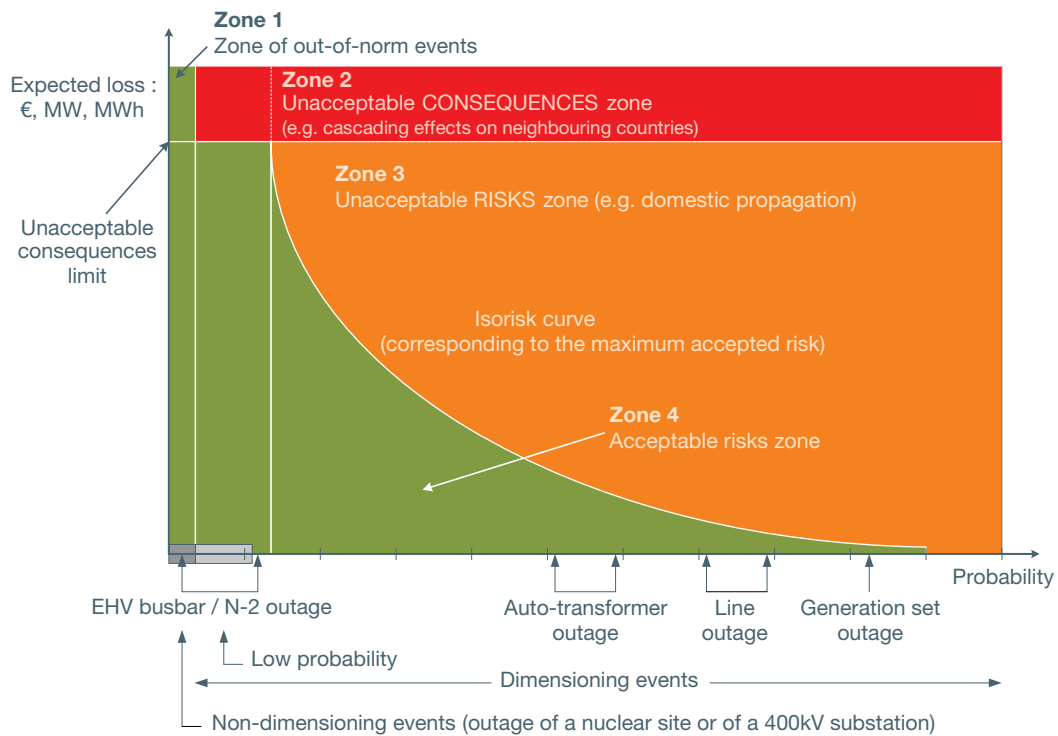

Figure 3. UCTE (now ENTSO-E)<sup>1</sup> iso-risk curve.

Source: ENTSO-E Operational Handbook

and typical column headings such as i) hazard/threat contingency; ii) possible corresponding event, disturbance; iii) probability of the event occurring; and iv) associated consequences. The results might also be mapped in a risk matrix with probabilities and severity of undesired events as axes and colored acceptability regimes. The so-called Frequency-Consequence diagram is one of the most meaningful ways to express the results of risk analysis and allows for risk levels that should be respected for all kinds of events and reference values as shown in Figure 3, formed by and taken from ENTSO-E Operational Handbook.

The risk assessment of power transmission systems is usually performed after the system design and planning phase. As an example, although the N - 1 principle is limited to operations, it should already be enforced in the system planning process of electric power grids, with the risk related to a specific contingency having been included as a constraint at the optimization phase.

Reliability is measured in terms of the probability that a system or a component is able to perform its required function at a given point of time, or over a given period of time, for a given set of conditions. With respect to the electric power system, reliability describes the degree of performance of the elements of the system that results in electricity being delivered to customers within accepted standards and in the

amount desired. Thus, electric power system reliability can be addressed by considering the ability

- to supply the aggregate electrical demand and energy requirements of the customers at all times, taking into account scheduled and reasonably expected unscheduled outages of system elements (“adequacy”)
- to withstand sudden disturbances such as electric short circuits or unanticipated loss of system elements (“security”)

While the term risk is used primarily to express uncertainty regarding adverse events, the concept of vulnerability (Hokstad 2012) is more directly related to the characteristics of a system. The focus in a vulnerability analysis thus moves away from the possibility that adverse events occur to system properties determining how easy it is to eliminate major system functions. For example, a vulnerability analysis of power supply aims to examine how the system is able to withstand adverse events and threats, such as line breaks, sabotage, and aging. Often, a vulnerability analysis extends the regular system limits, that is, it focuses not only on the number of affected end users, but also on the impacts, such as who is affected (e.g., a hospital or a key company in the region), and measures implemented to mitigate the consequences (e.g., mobile gasworks).

The concept of resilience has been developed and explored in various fields; there is no common accepted definition as yet. In general, resilience is the ability of a system to react and recover from unanticipated disturbances and events. To

<sup>1</sup> Disclaimer: “This document and other chapters of the UCTE Operation Handbook as well as excerpts from it may not be published, redistributed or modified in any technical means or used for any other purpose outside of UCTE without written permission in advance.” Copyright issues must therefore be discussed with ENTSO-E <https://www.entsoe.eu/publications/system-operations-reports/operation-handbook/Pages/default.aspx>



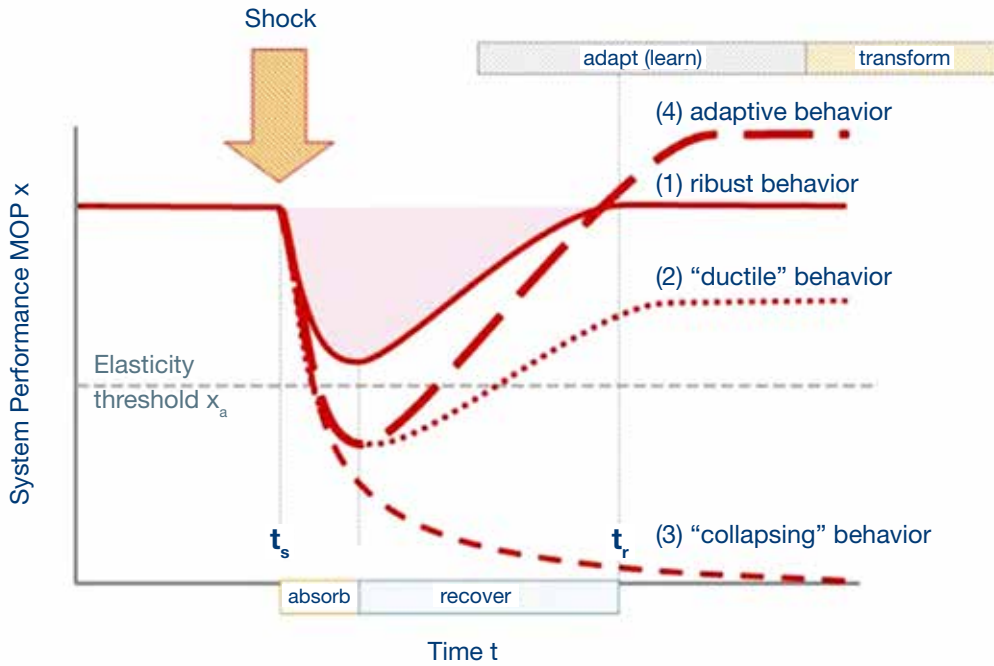

Four essential patterns,

- (1) absorbing a shock without collapsing,
- (2) recovering from a shock,
- (3) adapting through self-organization and learning, and
- (4) eventually transforming into a different system by altering structures, functions and feedback loops.

Figure 4. The essential patterns of resilient response behaviors

Source: Heinemann, 2014

elaborate, resilience is the ability of a system or a “system-of-systems” to resist/absorb the adverse effects of a disruptive force and the speed at which it is able to return to an appropriate functionality; the essential patterns are shown in Figure 4.

Depending on the extent of the capability of the electric power system to adapt, self-organize, and recover, system performance could either collapse to zero level or, on the other hand, recover and achieve even higher levels than before the shock.

The assessment of resilience in electric power grids helps identify best strategies to restore system operations and minimize performance losses. It also allows a quantification of the trade-offs between investing in system robustness or investing in system recovery. Indeed, a system which fails gracefully and does not experience large performance deviation but cannot achieve the target performance for extended time may not be more convenient or viable than a system that fails abruptly but is capable of promptly recovering its target performance value.

## 2. Characteristics of electricity networks, learning from past events

Electric power transmission systems are large-scale, multi-component, wide-area, spatially distributed, interconnected networks with numerous interdependencies, that are open to direct impacts (local or spatial). Some impacts are attributable to the usage of the system by market players. Those networks are highly integrated systems with complex behav-

iors, that is, with the potential for nonlinearities, dynamics, cascades, collapses, feedback loops, with weak dependence on other CIs besides ICT, in particular, for black starts.

As a hallmark of their inherent complexity, power grids have witnessed several blackout events in the last decade, as reported in Table 2. In particular, Figure 5 details the complexities associated with the system split that occurred in the synchronous European transmission system in 2006.

## 3. Conceptual and analytical frameworks and phases of RA

A conceptual framework for risk/vulnerability analysis of CI was proposed, for example, in Kröger and Zio (2011) to bring all system aspects and attributes together and to take advantage of the diverse capabilities of the available model and simulation approaches. Vulnerability analysis addresses several system issues: the end states of interest for the given systems; the boundary definition; the threats and hazards of relevance and the susceptibility of the system; the resulting cascades; system interdependencies and their impact; the uncertainties involved; the obvious and non-obvious (“hidden”) vulnerabilities to be reduced and managed.

The conceptual framework for vulnerability analysis follows a stepwise, problem-driven approach tailored to the needs of the analysis, and distinguishes five steps, several decision points, and feed-back loops (Figure 6).

Table 1. Major recent blackouts

Blackout	Loss [GW]	Duration [h]	Nos. affected	Main causes
14 Aug 03 Great Lakes, NYC	~ 60	~ 16	50 m	Inadequate right-of-way maintenance, EMS failure, poor coordination among neighboring TSOs
23 Sep 03 Denmark/Sweden	6.4	~ 7	4.2 m	Two independent component failures (not covered by N-1 rule)
28 Sep 03 Italy	~ 30	up to 18	56 m	High load flow CH-I, line flashovers, poor coordination among neighboring TSOs
12 Jul 04 Athens	~ 9	~ 3	5 m	Voltage collapse
25 May 05 Moscow	2.5	~ 4	4 m	Transformer fire, high demand leading to overload conditions
22 Jun 05 Switzerland (railway supply)	0.2	~ 3	200,000 passengers	Non-fulfilment of the N-1 rule, wrong documentation of line protection settings, inadequate alarm processing
14 Aug 06 Tokyo	?	~ 5	0.8 m households	Damage to a main line due to construction work
4 Nov 06 Western Europe (planned line cut off)	~ 14	~ 2	15 m households	High load flow D-NL-maintenance, violation of the N-1 rule, poor inter-TSO coordination
10 Nov 09 Brazil, Paraguay	~14	~4	60 m	Short circuit on key power line due to bad weather. Itaipu hydro (18 GW) shut down
11 Mar 11 Northern Honshu, Japan	21	days	40 m	Grid destruction by earthquake & tsunami/ supply gap/rolling blackouts
22 De 13 USA/CND blackout	22	few hours to 7 days	1 m	Massive damage to electric power transmission and trees due to freezing rain and snow from ice storm
31 Mar 15 Turkey	33	8	76 m	Combination of hydro production oversupply, reduced thermal generation and maintenance on east-west transmission lines

The first step, the preparatory phase (step 1) integrates the task framing and definitions into the process of familiarization with the system. It is also important here to decide on the spectrum of hazards and threats to be included into the analysis. Furthermore, it is necessary to deeply understand failure models and effects on each of the components. For a more effective screening of the system vulnerability, some reasonable simplifications should be made that need to be revisited at a later phase of the assessment. Furthermore, the knowledge base should be checked with respect to the availability of methods suitable for the defined tasks.

The purpose and goals of the analysis affect the degree of detail, for example, the assessment of interdependencies and cascading failures or the width of system boundaries. It is assumed that the vulnerability analysis should evolve in two steps where appropriate. A screening-type of analysis (step 2) could be efficient and sufficient to identify eye-catching, obvious weak points (e.g., awkward topology, spatial proximity of interconnected systems or bottlenecks) and further actions should focus on eliminating or reducing them. The screening analysis could also prepare the ground for, and give

steer to, the in-depth analysis which may turn out to be necessary and leads off with development of adequate system understanding; we assume that information provided from system owners/operators allows for general understanding of main functionalities, states of relevance, interfaces, and interdependencies. In this phase, the main emphasis is placed on experts' opinions, brainstorming, etc., rather than on application of detailed models. If the results and insights gained by screening analysis are not satisfying (not "clear-cut") and major hidden vulnerabilities are still feared, a more sophisticated in-depth analysis (step 3) has to be launched.

To achieve a higher degree of accuracy in the vulnerability evaluation, system understanding has to be further developed on the basis of additional information about the system and its operating environment. Special attention should be placed on interdependencies within or among systems. The reassessment of simplifications made earlier may call for more sophisticated methods of analysis and also for integrating a comprehensive spectrum of different phenomena. While full validation and verification of models and methods, and of results, seems infeasible, benchmarking against other similar

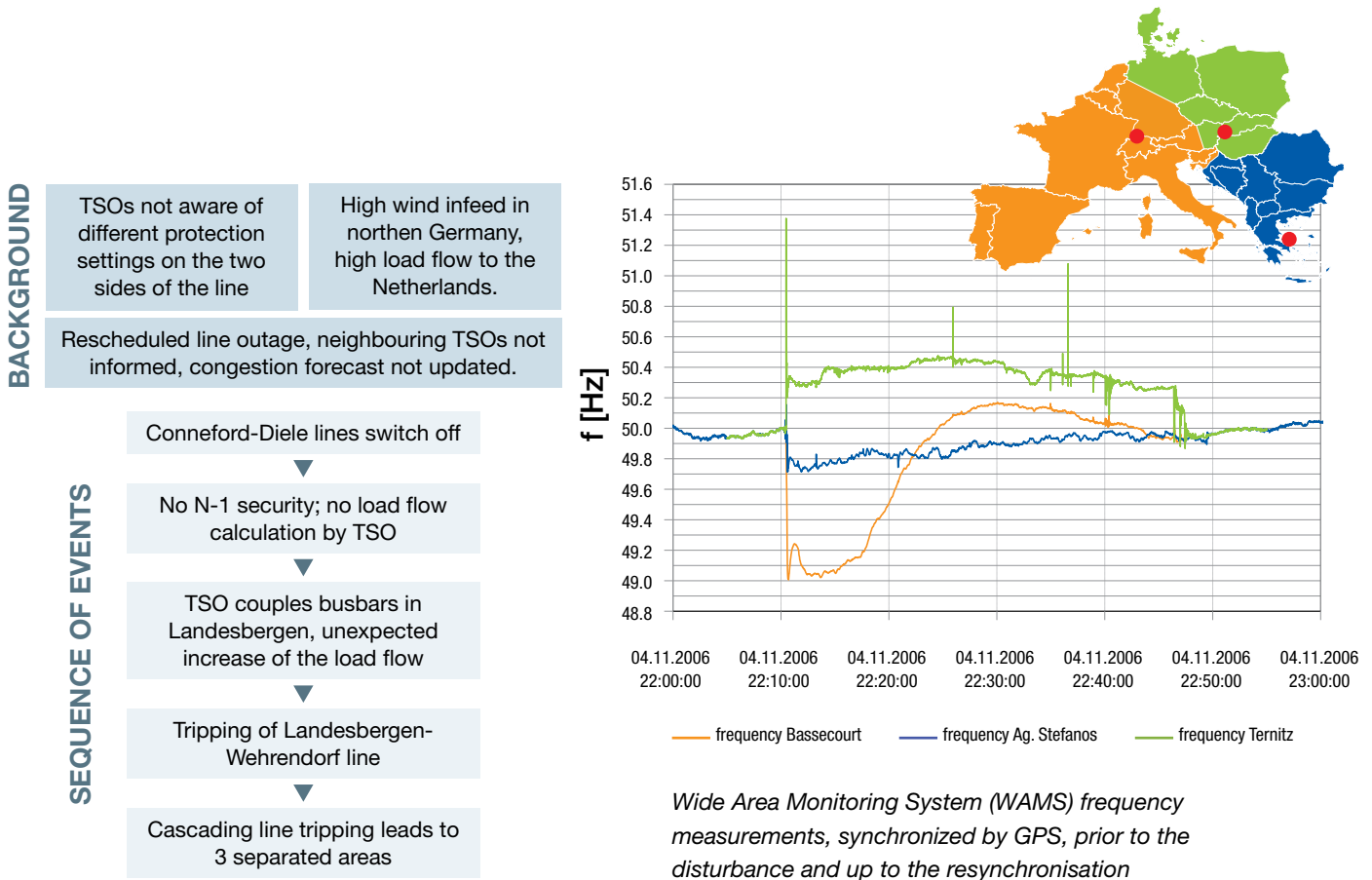

Figure 5. The system split that occurred in the Western European transmission system in 2006

Source: Final Report – System Disturbance on 4 November 2006, UCTE

analyses, plausibility checks, and checks against experienced events, if available, may help to support the credibility of the vulnerability assessment and build confidence in the decision making that follows. System improvements (step 5) may be proposed to further reduce and better manage vulnerabilities by all means of provisions.

#### 4. Overview of methods and approaches; associated data needs and computational effort

Applied modeling approaches have different viewpoints (e.g., functional or structural, different levels of abstraction, different focus, objectives and metrics, different degrees of maturity) and are based on different levels of available information and knowledge. It is commonly agreed that a universal, all-encompassing approach or model accounting for all issues does not exist. Three main methods can be distinguished, that is, knowledge-based investigations, model-based approaches, and best practices.

##### I. Knowledge-based investigations

These use statistical data, including information on blackouts and underlying patterns (see also Table 3.1) to make high-level aggregate inferences regarding future system behavior. Their applicability to specific power grids is limited due to the generalized results they obtain. Empirical investigations

or brainstorming aim to use data collected by interviewing experts and/or analyze past events to acquire information and improve the understanding of system vulnerability and risk. This knowledge-based approach is straightforward and easy to understand. It is capable of providing a qualitative assessment of the severity of system abnormal states and can be considered as an efficient screening method. However, it is a purely data-driven, knowledge-based approach, meaning that the accuracy of results depends on the quality and the interpretation of the information collected.

Data needs: statistical information on past events (e.g., triggering causes, chain of events leading to major losses, response of protection devices, impact on supply, duration of disruptions, etc.) can be accumulated from the reports compiled by the TSOs involved and national energy authorities.

##### II. Modeling and simulation

Advanced modeling approaches are available, have been applied, and are widely accepted, for example, Input-output Inoperability Modeling (IIM), Complex Network (CN) Theory, Agent-based Modeling (ABM), and others (see also, Kröger and Zio 2011).

The IIM approach captures dependencies among infrastructure systems via mathematical models. It assumes that each system can be modeled as an atomic entity whose level of

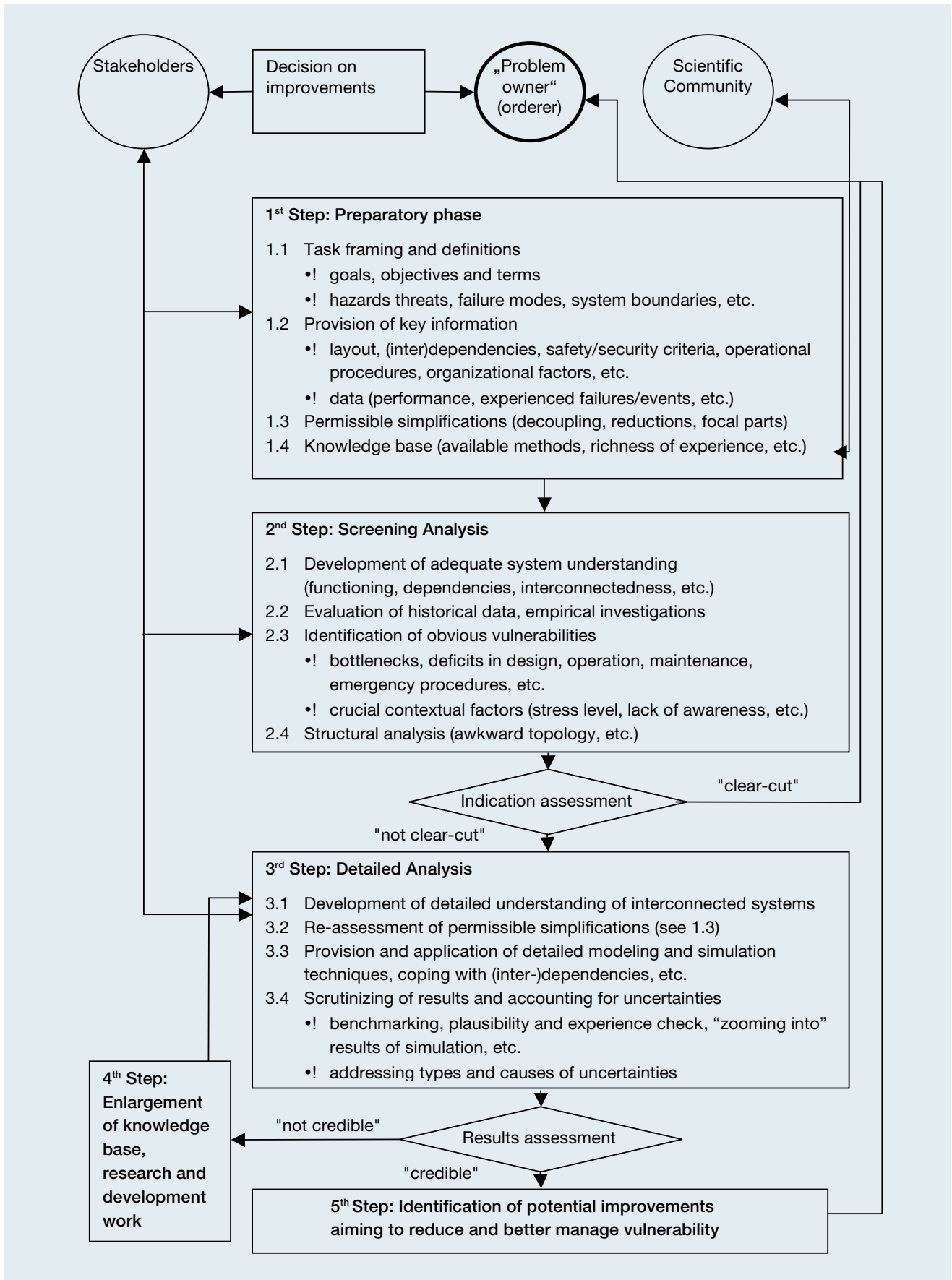

Figure 6. Conceptual framework for the risk/vulnerability analysis of interconnected infrastructures (flow chart-type of illustration; double arrows represent two-way interactions)

Source: Kröger and Zio 2011

operability depends on other systems and that propagation between them can be described mathematically based on the basic Leontief high order mathematical model. The IIM approach is capable of analyzing cascading effects into interdependent economic industries (e.g., societal impacts of blackouts; Haimes et al. 2005).

Fundamental elements of the CN theory approach are originally formed by graph theory. It captures the coupling among systems as a set of nodes connected by a set of links and thereby characterizes their topology. A number of modeling efforts have been undertaken to adopt this approach to develop infrastructure system models and interdependency-related assessments, and thereby demonstrate its capability of representing relationships established through connections among system components (Kröger and Zio 2011; Buldyrev 2010). The CN theory approach is based on the network model and maps physical configuration of the components (nodes) of studied infrastructure systems and their (physical or logical) interconnections (links). An analysis of the topological properties of the network reveals useful information about the structural properties, topological vulnerability, and level of functionality demanded for its components. However, this approach lacks the ability to capture uncertain and dynamic characteristics of infrastructure systems and system properties when dynamical processes, acting on the network, occur. For instance, the underlying physics of voltage collapse or frequency instability in electric power grids is overlooked by CN theory models.

In the ABM approach, each agent is characterized by internal data, its behavior, and its environment, and adapts itself to environmental changes (D’Inverno and Luck 2004). An agent can be used to model both a technical component (e.g., transmission line), and a non-technical component (e.g., human operator) (Schläpfer et al. 2008). The rules of the behaviors of each agent are represented by finite state machines and include both deterministic and stochastic time-dependent, discrete events. The ABM approach achieves a closer representation of system behaviors by integrating the spectrum of different phenomena that may occur, for example, generating a multitude of representative stochastic, time-dependent event chains. However, this approach demands a large number of parameters to be defined for each agent, which requires thorough knowledge of the systems studied.

Data needs: IIM requires the commodity flow exchange among the electric power sector and the other industrial sectors of economies. CN theory requires the knowledge of grid topology, and it can complement this with physical information, for example, line length, capacity, and impedance, for weighted approaches. ABM requires structural and electrical properties of the grid, and, depending on the level of modeling accuracy, may require data about protecting devices and operational procedures. The computational resources required increase with the amount of data needed.

These approaches are usually combined into hybrid models in order to synergistically profit from their strengths, for example, power flow models are integrated into ABM. As combined approaches are under development and subject to research advancements, they are not yet established as best practices.

III. Best practice methods with reference to Operational Handbook (i.e., N – 1 simulations for types of contingencies, e.g., load flow analysis, Real Time Estimator, and EPRI best practice methods.)

With respect to power system assessment models, three categories can be identified: I) security-constrained assessment; II) online risk-based assessment; III) cascading outage assessment.

I) Models for security-constrained assessment are used in system planning. These models employ optimization with respect to total costs and constrain reliability parameters (e.g., line flow or other stability indicators to be within a certain range after a contingency occurs). Examples are security-constrained optimal power flow for single (electricity) (Fu 2005) or multiple energy carriers (gas + electricity) (Liu 2009). Markets can be embedded.

II) Online risk-based assessment is used to assess whether the real-time state of the power system is secure with respect to several indicators (i.e., overloads, voltage instabilities, or cascading overloads) (Ni 2003). They exploit a system performance indicator for online assessment of the state of the power grid. Online assessment can also be included in an optimization loop; constraints include an indicator of cascading effects, called a cascading index (Dai 2012). Operational procedures or technical equipment are not captured by this assessment.

III) Models for cascading outages capture the propagation of a disturbance from the local level up to the systemic level. They rely on different level of abstraction. In power energy systems, these models represent the behavior of electric equipment following a system perturbation (Vaiman 2012). They can be static (use steady states solutions, i.e., power flow) or dynamic (include transients (Yan 2015)).

As these models quantify the extent and magnitude of blackouts, they fit a probabilistic risk assessment of power systems. Yet, they are difficult to develop and validate because the operational procedures executed by TSOs and technical equipment behaviors (automatic regulation) have to be captured. To this end, AMB may be helpful in representing operational procedures and technical equipment behaviors. The inclusion of operational procedures and technical equipment behaviors entails specific assumptions and undermines the generality and applicability of these models. Data needs:

Table 2. Checklist for the categorization of hazards and triggered events in the EPS

Level 1	Level 2	Level 3	Character	Triggered event	Probability judgment
<b>Natural (external)</b>	Meteoro-logical	Strong wind	m/p, d, a	Failure of above-ground power lines	
		Flooding			
		Extreme heat			
		Extreme cold, snowfall, ice rail			
		Extreme precipitation, induced landslides			
		Lightning			
	Geological/geotechnical	Snow slide			
		Land slide			
		Earthquake			
		Tsunami			
		Volcanism			
	Fire	Forest			
		Ling grass			
	Cosmic	Solar flare			
		Objects			
<b>Medical/biological Internal/external</b>	Human	Household disease			
		Pandemics			
<b>Technical</b>	Random failure	Line break	S, d, e		
		Tower break	S, d, e		
		Substation/transformers	S, d, e		
	Systemic failure, aging	Line break	S, d, e		
		Tower break	S, d, e		
		Substation/transformers	S, d, e		
		Structural collapse	S, d, e		
	Accident, fire (internal)	Transformer, substation			
		Control room			
	Nearby accident (external)	Industrial fire/explosion			
		Transportation (rail, road, aviation, marine), toxic release			
	Failure of support systems	ICT			
Unavailability of resources	Exchange/repair of components				
<b>Human unintentional</b>	Failure	Control room operator			
		Maintenance crew			
<b>Human-intentional behavior (insider, outsider)</b>	Malicious acts (physical, cyber)	Terrorism, destruction of critical components			
		Manipulation of SCADA			

Level 1	Level 2	Level 3	Character	Triggered event	Probability judgment
<b>Management, organizational and operational activities (inside/outside)</b>	Lack of safety culture, risk awareness	Top management		Interference with economic factors	
		Control room operators		Inadequate N – 1 simulations	
		Other relevant actors		Manipulated settings of protective devices	
	Lack of knowledge				
	Inadequate institutional programs	Lack of surveillance of safety-relevant activities			
Tree cutting programs				Induced flashover	
<b>Market/economics-related</b>	Undue economic pressure				

Models III.1 and III.2 require structural and electrical properties of the grid. Models III.3 also require data about protecting devices and operational procedures, depending on the level of modeling accuracy. Models III.3 perform grid simulations and are much more computationally demanding than III.1 and III.2.

## 5. Classification of hazards/threats; identification techniques including check lists

ENTSO-E OH provides a list of credible types of contingencies, which must be taken into account for N – 1 simulations. They are divided in a) normal types, i.e., loss of a single element; b) exceptional types, i.e., which could lead to cascade effects with non-negligible probability; and c) out-of-range types, i.e., loss of elements with very low likelihood.

To be more general and comprehensive, occurring hazards/threats may affect a single critical component(s) or a number of those components (m) or parts (p) of the EPS, either directly (d) or indirectly (i), i.e., via a failure of another system/service/function that the EPS depends on. The impact may be localized (l) or areal (a); the source can be external or internal. For example, an earthquake is large-areal, external, may affect multiple parts of the EPS directly (p, d) and/or indirectly (p, i). It can trigger events endangering the continuous electricity supply (“hazard/threat events”).

Hazards/threats can be categorized, levelized, and characterized, and triggered events can be associated to them. A probability judgment can also be assigned to these hazards/threats in order to assess whether they can be credible and included in the risk assessment. Table 3 provides a checklist

for the identification and categorization of hazards/threats and triggered events in the EPS.

Table 3 is meant for use of TSOs for the region of control as a checklist for the identification of the hazards in a specific area. Those hazards deemed irrelevant can be screened out from the following risk assessment. Table 6 has been filled with a few exemplary cases.

## 6. Identification of vulnerabilities and contingency scenarios, critical components analysis and countermeasures

TSOs use empirical investigations, statistical data, brainstorming, and blackout patterns to assess the severity of system abnormal states and discover bottlenecks, critical points, and critical operations. However, these tools are based on past experience and might lack predictive capabilities in some instances. They can therefore be complemented with model-based tools, which may unveil “unthinkable” or “unpredictable” scenarios.

Complex network theory methods can be applied to the analysis of CIs to a) help identify preliminary vulnerabilities by topology-driven and dynamical analyses and b) guide and focus further detailed analyses of critical areas. Topological analysis based on classical graph theory can unveil relevant properties of the structure of a network system (Albert et al. 2000; Strogatz 2001) by i) highlighting the role played by its components (nodes and connecting arcs) (Crucitti et al. 2006; Zio et al. 2008), ii) making preliminary vulnerability assessments based on the simulation of faults (mainly represented by the removal of nodes and arcs) and the subsequent

reevaluation of the network topological properties (Rosato et al. 2007; Zio et al. 2008).

The two main outputs of the vulnerability assessment by network theory are the quantification of system vulnerability indicators and the identification of critical elements. The information they provide is complementary: while vulnerability indicators are parameters encompassing the static or dynamic characteristics of the whole system, the identification of critical elements provides rankings of component criticalities with respect to their connectivity efficiency or their contributions to the propagation of failure through the network.

The pure topological structure can be complemented with weights extrapolated from the physical features of the power grid. For example, reliability and electrical “distances” can be combined in the vulnerability assessment of an electrical transmission system and used as weights for the network arcs of the graph representative of the system; by so doing, the vulnerability and centrality measures evaluated in the weighted analysis encompass the information on the physics of the service provided by the CI under analysis. Further, the analysis of the vulnerability of the network in terms of the degradation of its global efficiency due to the disconnection of a set of links allows the network elements (arcs or nodes) to be ranked with respect to their role in the network global communication efficiency.

## 7. Characterization and evaluation of impacts and cascades

Power system states are classified in relation to the grid or load/frequency risk levels and urgency of actions related to risks of propagation: (a) Normal: no risk for interconnected system operation. All consumption and production are in balance and requirements on ancillary services and framework conditions are met; frequency, voltage, and power flows are within their predefined and allowed limits, and reserve (margins) are sufficient to withstand predefined contingencies. (b) Alert: risk for interconnected system operation. System within acceptable limits. TSO has uncertainties to come back to a normal state after one or more contingency. (c) Emergency: deteriorated situation (including a network split at a large scale).

Higher risk for neighboring systems, security principles are not fulfilled, global security is endangered, and no guarantee of total efficiency of remedies to limit propagation to neighboring systems or to the whole ENTSO-E system. From this state, once stabilized, restoration of parts of the system can be undertaken (e.g., after load shedding or system split). (IV) Blackout: characterized by the almost total or total absence of voltage in the transmission power system with consequences abroad and the triggering of TSO restoration plans.

A blackout can be partial (if part of the system is affected) or total (if the whole system is collapsed). From this state, restoration is undertaken with stepwise reenergizing and re-synchronizing of the power system.

The complexity of electric power grids poses challenges to the most suitable methods or combination of methods to perform risk analysis. The specific characteristic of each method, the goals of the analysis, and the availability of data guide their selection. A general classification of all the possible combinations of these factors is achieved during the analysis of the specific system; nonetheless, specific examples can be identified. Models III.1 and III.2 (Section 4) do not allow for the quantification of events following a contingency, therefore their use in risk assessment is limited. Models III.3 (Section 4) provide the phenomenological evolution of the system state following a contingency by steady-state or dynamic assessment. Models III.3 in combination with ABM seem the most promising for the quantification of the impacts and cascades following initial contingencies. These models are mainly static because the applicability of dynamic security assessment in large power grids is still unfeasible.

The societal impact of lack of power supply can be estimated by integrating models III.3 and IIM to propagate the demand not served to customers up to financial losses stemming from the various industrial sectors of economies.

Given the broad span hazards, which can trigger various contingencies in the electric power grid, cascade diagrams might be useful for the assessment of the risk of cascading failures. These diagrams are represented in the usual frequency/magnitude axes and portray the risk of propagating failures for specific system operation set points. The associated severity can be measured either in power not supplied (i.e., demand not served to the customers) or energy unserved.

In view of the assessment of power network resilience, the duration of a loss of supply or of a blackout is a relevant measure to quantify the restorative capability of the system during recovery. To this end, a combination of models III.3 and ABM is suitable for capturing the interplay among TSO actions, operations of the power generating stations and the response of protection and safety equipment during the re-energizing transient following a black start.

In case of incomplete data, CN theory methods can be used as approximation of best-practice models. This application entails a strong level of approximation because the physics of the electric flow is only partially approximated by CN theory, which only considers the propagation along the shortest paths connecting pairs of components.



## 8. Inclusion of corrective, risk reducing, and resilience increasing measures

As outlined previously, the ENTSO-E Operation Handbook focuses on security aspects in operation (not in planning) with N-1 as a key principle to avoid and manage abnormal and insecure situations. However, disturbances may occur and be propagated over a wide area and within a short period of time. To handle such “deteriorated situations,” in which security principles are not fulfilled, global security is endangered, and the whole system may collapse (“blackouts”). Action must be taken against them either before automatic defense devices are activated or afterwards during restoration. OH Policy 5 deals with “emergency operations”: main issues concern i) the awareness of the system states; ii) defense plans at national level including under frequency load shedding and secured functions of control rooms; and iii) the restoration processes to return to normal operation with a complex sequence of coordinated actions (for details, best practice standards and guidelines see UCTE Operational Handbook).

As shown by past experience the deterministic N-1 principle and the associated concept of prevention and mitigation including emergency measures are – if diligently implemented – powerful tools to ensure high performance of the electric power system but insufficient to cope with multiple failures and a plethora of triggered, potentially cascading scenarios. This standard approach should therefore be complemented by a more holistic, probabilistic approach that strives to achieve increased resilience, in particular for planning purposes.

The robustness and resilience of the electric power supply system can be strengthened by following basic guiding principles, all under cost–benefit constraints:

- Allocate resource buffers/reserves, implement functional redundancy and diversity, ensure functionality of key coupled components (nodes, links), implement physical redundancy and diversity
- Decrease system connectivity, perform decoupling strategies (islanding, FACTS)
- Design a robust grid topology, i.e., balance interconnectivity by allowing both centralized and decentralized clusters, identify critical nodes and prevent them from spreading failures, optimize the grid structure (degree, connectivity) against random failures and targeted attacks
- Balance complexity as well as automation and human control
- Design for operation within safety margins, for capability of system reorganization in response to external changes, and enable self-regulation
- Use real-time measurements and N-1 security checks and implement adaptive feedbacks based on these
- Span hazards and threats and associated scenarios to all imaginable, including malicious cyber attacks; strive for

predictability by applying new knowledge and advanced modeling techniques, and use a framework to study interdependencies.

As a general rule reduce interdependencies (particularly the dependence of the electric power system on other infrastructures), as interdependent networks are significantly more vulnerable than their non-interacting counterparts (Kenett 2014).

## 9. Protection against cyber attacks/ manipulation of cyber-physical control systems

Electric power supply systems are automated and controlled by sensors and actuators and associated human interventions. As they are spatially distributed, timely data flow between field devices and the central control room. Control data and commands are transmitted through communication channels. The SCADA (Supervisory Control and Data Acquisition) systems – as a prominent example – has traditionally been a dedicated proprietary system and not connected to the outside world, while recently there has been a growing trend towards more general-purpose solutions and “commercial off-the-shelf software and hardware making it more vulnerable to a set of threats and risks they have not been exposed to before” (Hokstad 2012). For instance, control data are often of interest and used by trading units linked to the open access internet, thereby providing entry points to malevolent cyber-attacks, not directly constrained by the dynamics of the physical process.

There is clear evidence that industrial control systems such as SCADA systems are vulnerable to threats, STUXNET being the most informative example. Several types of targeted attacks can be disseminated through malicious links, for example, stealthy deception and false-data injection attacks, replay attacks, denial-of-service attacks, infected worm attack (manipulation of software).

Methods are available for both, for identifying threats and studying potential incidents/triggered event scenarios. Those methods comprise a standard on how to perform risk assessment for ICT systems (e.g., ISO/IEC 27001 – 2005, misuse case diagrams and attack trees) (Hokstad 2012).

Estimating the likelihood of information security attacks and incidents is commonly difficult due to a number of fuzzy factors, including rapid changes in technology and threats, as well as dominating political targets, intentional (bad) character of acts, and lack of available sound statistical data. Therefore, designing and operating such vital control systems as dedicated, isolated systems seem to be imperative, or at least worth considering.

## References

- Albert R, Jeong H, Barabási A-L, (2000). Error and attack tolerance of complex networks. *Nature* 406:378–382, 2000
- Buldyrev SV, Parshani R, Paul G, Stanley HE, Havlin S. (2010). Catastrophic cascade of failures in interdependent networks. *Nature*. 2010;vol.464:p.1025-8
- CIGRE, 2007. Technical Brochure No 325: “Review of On-Line Dynamic Security Assessment Tools and Techniques”, by Conseil International des Grands Réseaux Électriques WG C4.601, 2007
- Crucitti P, Latora V, Porta S, (2006). Centrality in networks of urban streets. *Chaos* 16(1–9):015113, 2006
- Dai, R., Pham, H., Wang, Y., and McCalley, J., (2012). Long-term benefits of online risk-based direct-current optimal power flow, Proceedings of the Institution of Mechanical Engineers, Part O: Journal of Risk and Reliability, vol. 226, no. 1, 65–74, 2012
- D’Inverno, M., and Luck, M., (2004). *Understanding Agent Systems*, Springer Series on Agent Technology, Springer-Verlag Berlin Heidelberg, 2004
- ENTSO-E (2012). Memo 2012, European Network of Transmission System Operators for Electricity, 2012
- Fu, Y., Shahidehpour, M., and Li, Z., (2005) “Security-constrained unit commitment with AC constraints,” *IEEE Trans. Power Syst.*, vol. 20, no. 3, pp. 1538–1550, Aug. 2005
- Haimes YY, Horowitz BM, Lambert JH, Santos JR, Lian C, Crowther KG. (2005). Inoperability Input-Output Model for Interdependent Infrastructure Sectors. I: Theory and Methodology. *Journal of Infrastructure Systems*. 2005;Vol.11:p.67-79
- Heinimann, H.R. 2014. *Future Resilient Systems*. Booklet. 60 p. Singapore-ETH Centre. 1 Create Way #07-01, Singapore 138602
- Hokstad, P., Ingrid, B., Utne and J., Vatn, (2012). *Risk and Interdependencies in Critical Infrastructures*, Springer Series in Reliability Engineering, Springer-Verlag London, 2012
- ISO/IEC 27001 (2005) *Information technology – Security techniques – Information security management systems – Requirements*, International Organization for Standardization (ISO) and the International Electrotechnical Commission (IEC), ISO/IEC 27001:2005
- Kenett, 2014, *Network of Interdependent Networks: Overview of Theory and Applications*, *Networks of Networks: The Last Frontier of Complexity, Understanding Complex Systems*, Springer International Publishing, 2014
- Kröger, W., and Zio, E., *Vulnerable Systems*, Springer-Verlag London, 2011
- Liu, C., Shahidehpour, M., Fu, Y. & Li, Z. (2009). Security-Constrained Unit Commitment With Natural Gas Transmission Constraints. *IEEE Transactions on Power Systems*, Vol. 24, No. 3, 2009
- Ni, M., D. McCalley, J., Vittal, V., and Tayyib, T., Online Risk-Based Security Assessment, *IEEE Transactions on Power Systems*, Vol. 18, No. 1, 2003
- UCTE (2009). *Continental Europe Operation Handbook, Appendix 3: Operational Security*, European Network of Transmission System Operators for Electricity, 2009
- UCTE (2004). *Continental Europe Operation Handbook, Glossary of terms*, European Network of Transmission System Operators for Electricity, 2004
- UCTE (2009). *Continental Europe Operation Handbook, P3 – Policy 3: Operational Security*, European Network of Transmission System Operators for Electricity, 2009
- UCTE (2015). *Continental Europe Operation Handbook, P5 – Policy 5: Emergency Operations*, European Network of Transmission System Operators for Electricity, 2015
- Rosato V, Bologna S, Tiriticco F, (2007) Topological properties of high-voltage electrical transmission networks. *Electr Pow Syst Res* 77:99–105, 2007
- Schläpfer M, Kessler T, Kröger W. (2008). Reliability Analysis of Electric Power Systems Using an Object-oriented Hybrid Modeling Approach. 16th power systems computation conference. Glasgow. 2008.
- Strogatz SH, (2001) Exploring complex networks. *Nature* 410:268–276, 2001
- Vaiman, S., (2012), “Risk Assessment of Cascading Outages: Methodologies and Challenges,” in *IEEE Transactions on Power Systems*, vol. 27, no. 2, pp. 631–641, May 2012.
- Yan, J., Y. Tang, H. He and Y. Sun, “Cascading Failure Analysis With DC Power Flow Model and Transient Stability Analysis,” in *IEEE Transactions on Power Systems*, vol. 30, no. 1, pp. 285–297, Jan. 2015
- Zio E, Sansavini G, Maja R, Marchionni G, (2008) An analytical approach to the safety of road networks. *Int J Reliab Qual Saf Eng* 15(1):67–76, 2008

## 1.2. Multi-risk assessment in critical infrastructure: The case of electricity transmission networks

Alexander Garcia-Aristizabal, Center for the Analysis and Monitoring of Environmental Risk (AMRA)

### Introduction

Recent disasters highlight the fact that natural or man-made events can trigger other events, leading to a significant increase in fatalities and damages. There is thus a growing demand from risk managers to implement multi-type hazard and risk assessments that take into account scenarios of cascading effects (Scolobig et al. 2014). The issue of vulnerability and performance of critical infrastructure is also attracting attention from both the policymaking and academic communities. The term “critical infrastructure” in general singles out those infrastructure elements that, if significantly damaged or destroyed, would cause serious disruption of a system. Disturbances in the services provided by these infrastructure systems can have serious implications for the economy, everyday life, and national security (e.g., Holmgren 2006). In this chapter we present a brief discussion of the implementation of multi-risk assessments for critical infrastructure, considering specific aspects of impacts of multiple natural hazards to electric networks (Figure 7).

A typical electricity transmission network includes a number of elements that we can group in different classes as power generation (“sources” in Figure 7), high and medium voltage transmission, and medium/low voltage distribution (“sinks” in Figure 7). In network analysis, such elements constitute the vertices of the network and are the main points of interest for the vulnerability analysis (e.g., Poljanšek et al. 2012; Cavalieri and Franchin 2014; Correa-Henao et al. 2013).

Adopting a multi-risk perspective provides a number of advantages: (1) the intrinsic risk harmonization allows for the comparison and ranking of different risks; (2) the identification and quantitative assessment of cascading-effect scenarios allows for the identification of possible consequence amplification, which is an important opportunity to increase preparedness; (3) a multi-risk perspective provides a framework for assessing the effects of possible mitigation options.

The intrinsic characteristics of both multi-risk analysis and network behavior make multi-risk implementation in network systems a complex task. Natural hazards have the capacity to cause physical damage to network elements; thus, the response of the infrastructure network is strongly dependent on the physical vulnerabilities of its constituent assets, which, in turn, are dependent on their structural characteristics (e.g., Poljanšek et al. 2012). The risks associated with different types of natural hazards, for example, volcanic eruptions, landslides, floods, or earthquakes (see e.g., Figure 7), are generally estimated using different procedures, leading to the incompara-

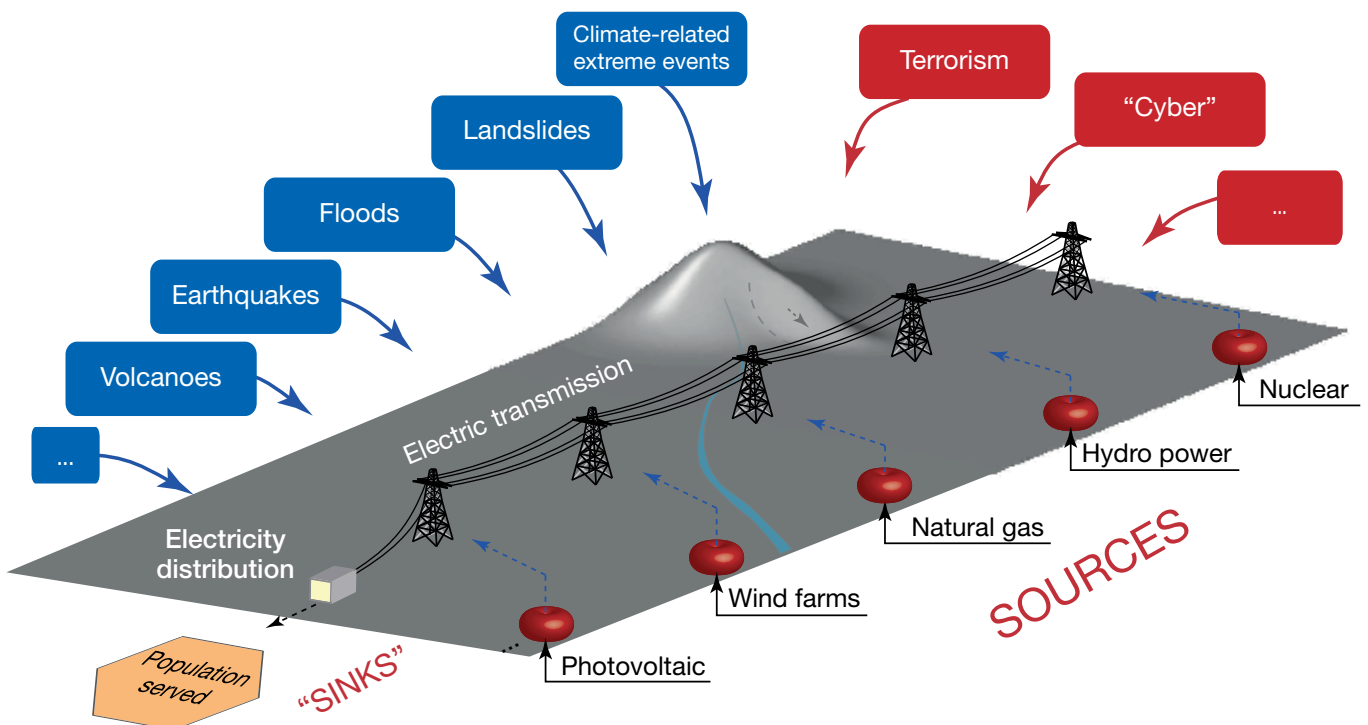

Figure 7. Representation of the electric network

Source: author

bility of individual results and the neglect of possible interactions (Marzocchi et al. 2012). However, the events themselves can be highly correlated (e.g., floods and debris flows could be triggered by an extreme storm event); one type of threat can trigger another, for example, an earthquake triggering a landslide), or several independent events may occur close together in time (e.g., hurricanes and earthquakes) impacting the same elements. The potential consequences associated with different hazards when considering their interactions may lead to the situation where their combination is much greater than simply the sum of their parts (Marzocchi et al. 2012).

## Multi-risk assessment in network systems

The multi-risk assessment may be understood as the process to determine the whole risk from several hazards, taking into account possible hazards and vulnerability interactions (e.g., Garcia-Aristizabal et al., 2015). Within this context, cascading effects are a consequence of interactions generated by cause-effect relationships among different phenomena. In the case of network behavior, however, cascading effects pertain not only to the events impacting the network, but also to damages spreading through the network; the last, depending on the connectivity of the network, defines how the vulnerability of each element influences the vulnerability of the network as a whole.

The nature of the interactions may be described by a wide set of phenomenological relationships, and this makes it difficult to set a generalized procedure for quantification of cascading effects. To simplify the setting of this problem in a multi-risk framework, we can consider the following two major sets of interactions: i) interactions at the hazard level and ii) interactions at the vulnerability level (see e.g., Garcia-Aristizabal et al. 2015a; Marzocchi et al. 2012). It is worth noting that complexity and the ubiquitous random effects that may affect these processes make probabilistic approaches the most appropriate way of quantitatively characterizing such interactions.

The interactions at the hazard level are relevant for the identification of sequences of events impacting one or more elements of the network. The problem at hand is to identify and quantify possible chains of adverse events in which the occurrence of one hazardous event entails a modification of the probability of occurrence of a secondary event, and where any event from the sequence can have an impact on the network system. The physical phenomena that can be grouped under this class are those cases in which an initial event produces a perturbation that, when acting on a given system, may bring it to an unstable state, forcing it to find a new equilibrium matching the changing conditions (e.g., a new morphological equilibrium after a debris flow event). Reaching this new equilibrium may imply the occurrence of an event that, in this case, may be said to be triggered by the initial one (Gasparini and Garcia-Aristizabal 2014; Liu et al. 2015).

Regarding the interactions at vulnerability level, the problem is to assess the consequences of the simultaneous action of two or more events (not necessarily linked among them) on the response of a given typology of exposed elements (e.g., a structure). This kind of interaction is therefore referred to the case in which the occurrence of one event (the first one occurring in time) may alter the response of the impacted elements to another event. In this case, it is assumed that two or more events act on a set of network elements and that the additive or cumulated effect produces a change in the response of the system with respect to the conditions that existed before the first occurring event. The cases that can be grouped under this kind of interaction are of different natures; in general, the physical processes of interest are those related to the response of the system to the loads caused by different events, taking in account their additive or cumulated effects. Note that the different events may be of the same nature (i.e., same kind of hazards, as, for example, two earthquakes shaking the same structures in a short-time window) or coming from different kinds of phenomena (e.g., the shaking caused by an earthquake as the first event, followed by loads caused by a landslide or by strong wind). Note also that the different events causing additive loads can themselves be the result of a common triggering event or may be independent events, and this relationship is important for the quantitative analyses.

Figure 8 illustrates the main elements for the multi-risk assessment of cascading effects with respect to electricity transmission networks. First, an exhaustive set of cascading scenarios need to be identified and structured (Figure 8a). The relevant scenarios can be identified through implementation of an adaptive scenario-structuring strategy (e.g., Haimes 2009), which results from combining forward and backward logic approaches. The forward logic analysis consists of identifying possible outcomes from each initiating event (e.g., a flood or an earthquake) following an event-tree-like structure. The backward logic strategy begins with an endpoint (effect) and works backwards to find the most likely causes of the effect, following a fault-tree-like structure. The combination of both approaches stems from the idea of iteratively using forward and backward logic approaches and combining the results obtained to exhaustively identify all the relevant scenarios for the specific problem at hand. A first screening of the identified scenarios can be performed using a qualitative approach, whereas a transition to semi-quantitative and detailed quantitative analyses is required to analyze the most relevant scenarios. Liu et al. (2015) present a method for objectively driving such a transition from qualitative to quantitative analyses in multi-risk assessments.

Once the relevant scenarios have been screened, it is possible to proceed with detailed quantitative assessments of the interactions. To do this, the conditional probabilities representing the interactions both at the hazard (Figure 8b) and at the vulnerability (Figure 8c) levels need to be calculated. The

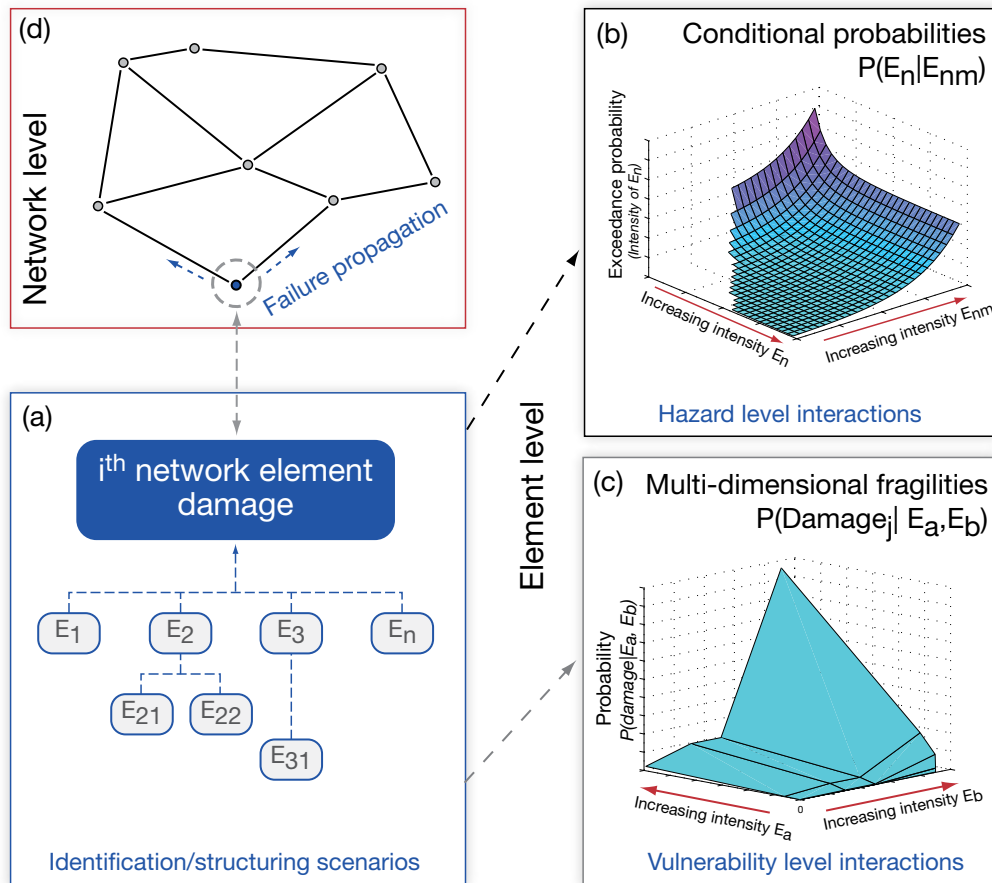

Figure 8. Assessing cascading effects in a multi-risk framework

Source: author, panels (b) and (c) modified from Gasparini and Garcia-Aristizabal 2014

hazard level interactions are generally assessed with respect to the intensity of the triggering event and its capacity for triggering a secondary event of a given size. This assessment may result from statistical analyses of databases or from performing physical modeling. On the other hand, multi-dimensional, damage-dependent fragility functions are required for assessing the interactions at the vulnerability level (Figure 8c). Fragility functions are a widely used tool to assess the vulnerability of physical elements to a given type of hazard; they are dependent of the intensity measure used to characterize the hazard. The multi-dimensional fragilities are then functions that depend on a set of intensity measures from different hazards, taking into account their additive or cumulated effects (see e.g., Gasparini and Garcia-Aristizabal 2014; Liu et al. 2015).

After calculating the failure probabilities of each element (by combining the hazard and vulnerability information), it is possible to use network analysis tools to assess the connectivity characteristics of the damaged network (Figure 8d). The aim of network analysis is to study how the performance of a network is affected by the removal of elements; in this way, it is possible to determine how a change in the network's structure affects the network vulnerability. It is worth noting that, in a given scenario, every element of the network can be exposed

to different typologies of hazards, and likewise each hazard to different hazard intensities (this is a consequence of the spatial distribution of both the network and the hazard intensity). The damaged network configuration can be generated once we determine which elements have failed; as the number of required scenarios is normally high, this process is generally computationally intensive. For that reason, Monte Carlo simulations are one of the most frequently adopted approaches to track this kind of problem (e.g., Cavalieri et al., 2014). The output of the network analysis generally relies on the analysis of predefined performance measures such as, for example, connectivity loss or the impact on the population served.

### Applied example

An example of a multi-risk assessment with respect to cascading effects involving electric networks was presented by Garcia-Aristizabal et al. (2014, 2015b). In these studies, different possible scenarios of cascading effects triggered by earthquakes were analyzed. Beyond assessment of the direct impacts of the earthquakes (main shock and triggered seismic sequence) on the built environment, the authors present a quantitative assessment of a cascading scenario in which earthquakes may cause a failure in a medium-voltage

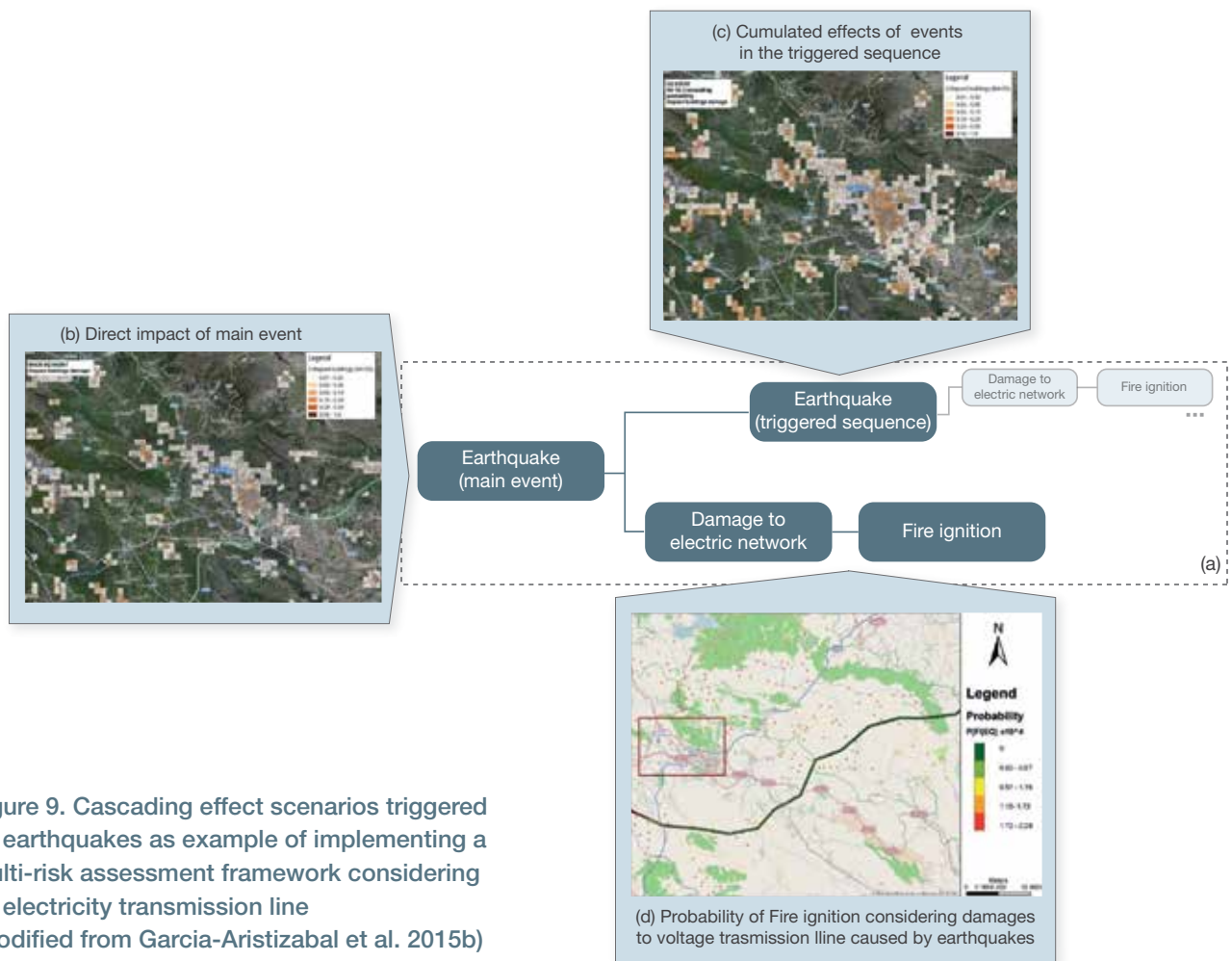

Figure 9. Cascading effect scenarios triggered by earthquakes as example of implementing a multi-risk assessment framework considering an electricity transmission line (modified from Garcia-Aristizabal et al. 2015b)

transmission line which, in turn, may potentially ignite a fire (Figure 9). The example is based on the simulation of an earthquake sequence occurring in the surroundings of L'Aquila province (Abruzzo, Italy). A set of cascading-event scenarios was identified for this example, a subset of which is represented in Figure 9a. Figure 9b shows a map with the assessment of expected structural damages in buildings caused by the direct impact of the main shock, whereas Figure 9c shows an assessment of the expected impacts caused by the successive triggered seismic sequence. Regarding the scenario involving the electric network, Figure 9d shows a map representing the probability of fire ignition, considering the potential damages in different segments of the electric transmission line (caused by the earthquakes) and the availability of fuel in the surrounding areas.

### Final remarks

The discussion presented in this chapter focuses on a description of the physical aspects of multi-risk assessment. However, the consequences of multiple natural events impacting a network system are of a different nature, ranging from direct to indirect consequences, both tangible or intangible. Holistic multi-risk analyses also requires the indirect tangible consequences to be integrated (see e.g., Garcia-Aristizabal et al. 2015), but network analysis under such conditions is complex. Optimization-based approaches (e.g., Han and Da-

vidson 2012; Miller and Baker 2015) can be a valid strategy to make such a multi-risk analysis a computationally feasible task. Such approaches often use proxy measures as indirect indicators for network performance, which are usually more tractable measurements (Miller and Baker 2015).

### Annex: Glossary

In the context of this chapter, the following definitions are adopted (adapted from selected references):

**Cascading effect scenario:** is a synoptical, plausible, and consistent representation of a series of actions and events, in which an event triggers or interacts with one or more sequential events.

**Fragility function:** a probability distributions indicating the probability that a component, element, or system will reach a damage state as a function of a predictive demand parameter.

**Multi-risk assessment:** determining the whole risk from several hazards, taking into account possible interactions at the hazard and vulnerability levels (see also "cascading effect scenario").

**Vulnerability:** this concept is defined, interpreted, and applied in various ways depending on the research field and context in which it is applied. In the context of this chapter we adopt the "physical" dimension of vulnerability, understood as the probable damage to an element at risk given a level of intensity of an adverse event (see also "fragility function").

## References

- Cavalieri, F., P. Franchin, J.A.M. Buriticá Cortés, & S. Tesfamariam (2014), Models for Seismic Vulnerability Analysis of Power Networks: Comparative Assessment. *Computer-Aided Civil and Infrastructure Engineering*, 29: 590–607, doi: 10.1111/mice.12064
- Correa-Henao, G. J., J. M. Yustab, & R. Lacal-Aránategui (2013). Using interconnected risk maps to assess the threats faced by electricity infrastructures, *Int. J. of Crit. Infrastructure Protection* 6:197-216, doi: 10.1016/j.ijcip.2013.10.002
- Garcia-Aristizabal, A., P. Gasparini, & G. UHINGA (2015a). Multi-risk assessment as a tool for decision-making. *Future Cities*, 4 (Climate change and urban vulnerability in Africa, Pauleit et al., Eds.):229-258, doi: 10.1007/978-3-319-03982-4\_7
- Garcia-Aristizabal, A., M. Polese, G. Zuccaro, M. Almeida, and C. Aubrecht (2015b). Improving emergency preparedness with simulation of cascading events scenarios. *Proceedings of the 12th International Conference on Information Systems for Crisis Response and Management* (Palen, Buscher, Comes and Hughes, eds.), Kristiansand, Norway.
- Garcia-Aristizabal, A., M. Almeida, C. Aubrecht, M. Polese, L.M. Ribeiro, D. Viegas, and G. Zuccaro (2014). Assessment and management of cascading effects triggering forest fires. In “Advances in Forest Fire Research” (D. Viegas, Ed.), pp 1073-1085. doi: 10.14195/978-989-26-0884-6\_117
- Gasparini, P. & A. Garcia-Aristizabal (2014). Seismic Risk Assessment, Cascading Effects. In: Beer M., Patelli E., Kougioumtzoglou I., Au I. (Ed.) *Encyclopedia of Earthquake Engineering*, SpringerReference, p. 1-20. Springer-Verlag Berlin Heidelberg. doi: 10.1007/978-3-642-36197-5\_260-1
- Han, Y. & R.A. Davidson (2012). Probabilistic seismic hazard analysis for spatially distributed infrastructure. *Earthquake Engng Struct. Dyn.* 41(15):2141-2158, doi:10.1002/eqe.2179
- Haines, Y. Y. (2009). *Risk Modeling, Assessment and Management* (3<sup>rd</sup> ed). John Wiley & Sons Inc., Hoboken, New Jersey.
- Holmgren, Å. J. (2006), Using Graph Models to Analyze the Vulnerability of Electric Power Networks. *Risk Analysis*, 26: 955–969, doi: 10.1111/j.1539-6924.2006.00791.x
- Liu, Z., F. Nadim, A. Garcia-Aristizabal, A. Mignan, K. Fleming, & B. Luna (2015). A three-level framework for multi-risk assessment. *Georisk: Assessment and Management of Risk for Engineered Systems and Geohazards* 9, doi: 10.1080/17499518.2015.1041989
- Marzocchi, W. A. Garcia-Aristizabal, P. Gasparini, M. L. Mastellone, & A. Di Ruocco (2012). Basic principles of multi-risk assessment: a case study in Italy, *Nat. Hazards*, 62(2): 551-573, doi: 10.1007/s11069-012-0092-x
- Miller, M., & Baker, J. (2015), Ground-motion intensity and damage map selection for probabilistic infrastructure network risk assessment using optimization. *Earthquake Engng Struct. Dyn.*, 44: 1139–1156, doi: 10.1002/eqe.2506
- Poljanšek, K., F. Bono, & E. Gutiérrez (2012), Seismic risk assessment of interdependent critical infrastructure systems: The case of European gas and electricity networks. *Earthquake Engng. Struct. Dyn.*, 41: 61–79, doi: 10.1002/eqe.1118
- Scolobig, A., A. Garcia-Aristizabal, N. Komendantova, A. Patt, A. Di Ruocco, P. Gasparini, D. Monfort, C. Vinchon, M. Bengoubou-Valerius, R. Mrzyglocki, & K. Fleming (2014). From multi-risk assessment to multi-risk governance: recommendations for future directions. Chapter 3-20 in: *Understanding risk: The Evolution of Disaster Risk Assessment*, Editor: Global Facility for Disaster Reduction and Recovery (GFDRR). World Bank: 163-167

## 1.3. Multi-hazard perspectives for power network resilience

Friedemann Wenzel and Christopher Zobel,  
Geophysical Institute of the Karlsruhe Institute of  
Technology (KIT), Germany and Pamplin College of  
Business, Virginia Tech, Dept. of Business Information  
Technology, Blacksburg, USA

### Abstract

In recent years there have been many power interruptions and failures caused by natural disasters, some of them influenced by more than one type of hazard. Because of the inherent complexity of such situations, multi-hazard and multi-risk analysis are needed to appropriately manage their impacts. On the risk side, power supply interruptions can affect an area much larger than the hazard-stricken region itself, and there is a high potential for such interruptions to cause indirect losses to businesses. Such events can also have a significant continuing impact during post-disaster response and reconstruction. To add to this complexity, not only do power supply networks change over time, but they can also change their characteristic features as networks. Approaches for managing such disruptions must therefore be responsive and flexible, and they must consider both the immediate impacts of a disruption and the longer-term process of recovery. To address this need, this chapter adopts a resilience perspective on the process of managing multi-hazard situations and conducting risk assessment and mitigation.

### Cases

There are many reported cases of natural disasters causing power losses. We begin by providing a number of examples of such disasters in order to illustrate the wide range of hazards, from hydro-meteorological and geological/geophysical incidents to space disasters, to which power systems may be exposed.

Despite the variety of different events represented in this list, notice that each one is nevertheless presented as involving only a single type of hazard. Almost without exception, such situations will typically involve multiple interrelated hazards that occur either simultaneously or in a cascading fashion.

The recent Nepal M7.9 earthquake of 24 April 2015 is an example of a multi-hazard situation: the ground shaking triggered widespread landslides, which not only destroyed residential buildings and caused loss of life but also blocked roads and interrupted the power supply. This initial combination of events led to significant economic losses and made relief operations much more difficult. The situation also increased the potential for the displaced soil masses to become

Table 3. Cases of natural disasters causing power losses

<b>Brush fires:</b>	On 17 May 1985, a 10 acre brush fire in the Florida Everglades damaged overhead transmission lines, causing a blackout across much of South Florida for several hours. A total of about 4.5 million people were impacted, including the entirety of the cities of Miami and Fort Lauderdale (Ft. Lauderdale Sun-Sentinel, 1985).
<b>Storms and hurricanes:</b>	<p>On the night of 16 October 1987, the strongest storm in England for nearly 300 years, the so-called Great Storm of 1987, blacked out the City of London for six hours, and caused approximately £2 billion in damage (Kinder 2013).</p> <p>Winter storm Anatol struck Europe on 3 December 1999, and was followed on 26–28 December 1999 by extratropical cyclones Lothar and Martin. The combination of storms brought severe damage to thirteen countries, and 10 million people across France and Germany were left without power. A fourth of France’s high-tension transmission lines were destroyed and 300 of its high-voltage transmission pylons were knocked down; it ultimately was described as one of the most significant energy disruptions ever been experienced by a modern, developed country (Tatge 2009).</p> <p>When Hurricane Katrina came ashore on 29 August 2005, it led to more than 2.7 million people in Louisiana and Mississippi losing power (USDOE 2005). This was in addition to the 1.3 million people who had lost power in southeastern Florida when it made landfall there several days earlier (NOAA 2005).</p> <p>On 27–28 August 2011 Hurricane Irene caused over 4.3 million people on the east coast of the United States to lose power, ranging from North Carolina to Massachusetts (Gonzalez 2011).</p> <p>On 29 and 30 October 2012, Hurricane Sandy struck the eastern United States, bringing high winds and significant flooding. It ultimately left an estimated 8.5 million homes and businesses without power across 16 states and the District of Columbia (WITN 2012).</p>
<b>Earthquakes:</b>	<p>1.4 million PG&amp;E customers lost power on 17 October 1989, when the Loma Prieta earthquake struck Northern California and damaged a number of transmission substations (National Research Council 1994).</p> <p>On 22 February 2011, a 6.3-magnitude earthquake struck the city of Christchurch, New Zealand. Direct costs to the electric power distribution network operated by Orion New Zealand Limited were estimated at over \$40 million, and it took approximately 10 days before power was restored to 90% of the company’s customers. The underground cable network was particularly impacted by the earthquake (Kestrel 2011).</p> <p>As a result of the Tohoku earthquake of 11 March 2011 in Japan, the Tohoku Electric Company immediately lost about 55% of the gross capacity of its fossil-fired and geothermal plants. As a result, around 4.4 million of their customers lost power (Kazama and Noda 2012).</p>
<b>Landslides:</b>	On 29 July 1999, a landslide in Taiwan cause the #326 transmission tower to collapse, disconnecting about 8.5 million people from the electric power grid (Lee and Hsieh 2001).
<b>Geomag-netic storms:</b>	On 13 March 1989, a geomagnetic storm caused the entire Hydro-Québec power system to collapse in just over 90 seconds. The predominance of hydropower generation in the system allowed for 83% of the total load to be restored within 11 hours (Kappenman 2010).
<b>Ice storms and snow:</b>	A severe ice storm impacted Spokane, Washington, on 19 November 1996, causing half of the city to lose power and leaving some residents without electricity for up to two weeks. The total damage were estimated at over \$22 million (NOAA 2013).
<b>Heat waves:</b>	On 10 August 1996 power surges due to high summer heat caused a cascading power failure that forced the Pacific Intertie, the main power artery between the Northwest and California, to shut down, blacking out power to more than four million people in nine states (Golden 1996).



mudflows once the monsoon started in June. If some of the slopes had been brought close to failure by the ground shaking, they could easily have slid with the increased precipitation that comes with the monsoon. This could then have distorted the initiated reconstruction efforts as well.

In the following discussion we reflect on current definitions used in the multi-hazard context and plead for simplification that seems to be justified from a resilience management perspective. Methodologies used in hazard and risk assessment are briefly presented and a more systemic view is developed by considering power supply systems not as static but as dynamic structures. Finally, we introduce the notion of resilience and explicitly address potential options for improving such resilience in these complex situations.

## Multiple hazards – Definitions

Multi-hazard and multi-risk assessment can be understood in different ways. For risk management one tries to include different perils in the risk assessment process by making their impacts comparable. This can be done easily if the impacts are quantified strictly in monetary values, as this provides a common basis for comparison. Otherwise, if the risk metrics are more complex, for instance, because they include intangible items such as cultural heritage and political stability, then indicator-based systems or rankings following expert judgment are common.

In contrast with cases where the events in different perils are independent and have no temporal relationship, there are also cases where several hazards and risks can coincide in time and even be causally related. These events are mostly addressed in the current scientific and engineering debate (Schmidt et al. 2012; Kappes et al. 2012; Marzocchi et al. 2012). The causally related hazards and risks are of particular interest as they are more demanding in scientific and operational aspects and have the capacity to develop into great disasters through cascading effects. In mountainous areas an earthquake often triggers landslides. If a large rock or soil mass slides into a dammed reservoir, it may spill over and create a flood downstream from the river that was dammed. Volcanic eruptions and earthquakes occur frequently together or in sequence, sometimes also generating a local tsunami. These interconnected events can be addressed either by logic trees or Bayesian chains (Mignan et al. 2014).

However, we adopt the view that the hazards in the cases mentioned are – from a risk management perspective – one hazard only. A major earthquake with magnitude large enough to rupture the entire crust of the Earth includes the “secondary” hazards of triggered landslides, liquefaction, tsunami, and if the fault is located in the ocean and the earthquake has a significant thrust component, seiches, aftershocks, and earthquakes triggered in the vicinity. These

are not separate events but expressions of the same main phenomenon.

Different hazards may occur more or less simultaneously by chance. This appears at first glance very unlikely. However, it is actually not if we (a) look at combinations of rare events, for instance, a big earthquake and more frequent events and (b) understand disasters from a resilience perspective so that one looks at the impact, the response phase, and the recovery period, which may range on a scale of years. The immediate impact of an earthquake in terms of economic loss and fatalities does not strongly depend on the weather conditions. However, adverse conditions like very low temperatures or heavy monsoon, which may occur every few years, will make rescue and response much more difficult and cause consequential losses.

The relevance for power supply networks depends very much on their resilience. If repair and restoration times are short, as provisions against disasters have been implemented, the chance of a multi-hazard impact is reduced automatically. For operational purposes it is important to distinguish between brownouts (partial outages) and blackouts (total outages), rolling black-outs, etc. Different conditions with regard to safety, losses, and restoration times apply if only parts of the network are without power instead of the entire one. In the following we ignore these distinctions, as the focus of the paper is on the hazard aspects.

## Methodologies for multi-hazard and multi-risk assessment

Disasters can have wide-ranging implications for the generation of power, its distribution, and its customers or users. The potential loss pattern is thus far more complex than is indicated by the assessment of risk for a particular building or set of buildings. When the interrelated potential impacts of multiple events of such a kind are also taken into account, this further complicates the situation and the analysis.

In risk analysis for natural disasters, one considers the hazard in a particular parametrization, the vulnerability of structures, the exposure of these vulnerable entities, and finally the expected losses within a given time period. Hazard parameters are chosen after consideration of the structures at risk. For earthquakes this is ground motion, as peak acceleration or peak velocity of the surface, duration of shaking, etc. For floods this can be height, duration, streaming velocity, etc. of the inundation. For storms, it is usually gust velocity. A hazard’s characteristics can be provided by scenarios and also as probabilistic quantities, where the exceedance probabilities for values of the hazard parameter within a pre-defined period of time are specified (for instance, 50 years for buildings). Vulnerability is then measured as the mean damage ratio (= mean expected percentage damage) of the

object at risk, given a certain level of the hazard parameter. The financial component of risk can be measured, with many metrics related to direct economic losses (for instance, the replacement value of the damaged parts of the power generation and supply system), as well as indirect economic losses (consequential losses to objects, businesses, institutions, that while experiencing no direct damage did not function due to loss of power). Such economic losses, which are strongly dependent on downtime, are obviously a significant part of risk analysis in the context of power systems. Another type of loss is that associated with social impacts related to the loss of power (non-functional hospitals, lack of heat in winter or cooling in hot summers) that can create injured and/or traumatized persons. On a local scale, individuals can be impacted by live electric lines brought down by strong winds. On a larger scale, the loss of power during periods of very hot or very cold weather can negatively impact large numbers of people, particularly the more susceptible segments of the population, such as the elderly or infirm.

Different disasters vary in terms of their hazard parameters and in the associated frequencies of their occurrence, the inverse of which is the return period; they also vary in terms of the real extent to which they might be affected by the disaster, its duration and evolution. Earthquakes occur suddenly without warning but are short on the scale of minutes. At higher magnitudes they affect large areas but are then rare at a given site. Floods may occur much more frequently and can have a long duration if precipitation is extensive. They also affect large areas. However, they are dependent on topography and evolve over time subject to the amount of precipitation (also how saturated the soil is from previous weather conditions). They propagate along the rivers in the catchment area so that early warning and appropriate response can save lives and property. Apart from the hazard the loss pattern is also different.

The key point here is that different hazards are difficult to compare. If the risk metric is direct economic loss, the difference is only the hazard. In this case, the rare earthquake can cause much higher losses compared with the more frequent floods with their smaller losses. This was actually found in a study (Gruenthal et al. 2006), which compares direct economic losses to the city of Cologne in Germany for floods, earthquakes, and winter storms. The value of interest is the annual average loss that is comparable between floods and earthquakes.

A standard approach to “compare” and weight the impact of different disasters on a risk target, which can be applied even in cases where detailed probabilistic hazard and loss models are not available, is the “risk matrix” (Garvey 2008). Different disaster types are evaluated in the form of scenarios, which need to be associated with a frequency of occurrence, the losses being evaluated in terms of intensity of impact. Fre-

quency and intensity are often categorized as high, medium, and low, which requires appropriate expert judgment.

## Hazards and changing power supply systems

Several countries are in the process of changing their power supply systems from centralized to decentralized systems. This is one consequence of the widespread introduction of renewable energy forms which implies the introduction of many decentralized power generation methods (wind, solar, geothermal, bio), the reduction of base supply capacity by the big utilities, and higher reliance on the networks that distribute power to industrial and private customers with networks of growing complexity.

The distribution systems are the most vulnerable parts of the system. Most failures occur because of damage to this system that propagates across the network. In some cases (geological disasters) sub-stations are also damaged. Nevertheless, the growing complexity of the distribution system represents an immanent exposure to natural disasters.

The intent of the smart grid is to use technology to make such decentralized networks more effective and more efficient. By implementing technology that allows for localized control, power networks can take advantage of several opportunities: i) grow from the bottom up in a modular way – complement the existing structure without needing to replace it; ii) different modules can continue to function whether connected to the main grid or not; iii) disruptions can be isolated from the rest of the system to reduce cascading failures; iv) unused energy can be fed back into the system to better balance demand between peak and off-peak hours; v) renewable energy sources can more easily be connected (Farhangi 2010).

Issues with the smart grid include the lack of robust standards for new technologies, and the associated difficulty of interfacing new and old technologies. Cost is also an issue, as is governmental support; the potential for cybersecurity issues is also of increasing concern, as more control is brought online, particularly with the growing complexity and less human oversight (Holmukhe and Hegde 2015).

## The resilience perspective

Disaster resilience has many definitions, but is generally considered to provide a means of representing a system’s ability to rebound from a disaster. Much work has been done on characterizing the inherent characteristics of communities that support resilient behavior (Cutter et al. 2013), but it is also important to look at the system behavior in response to a particular event – how much loss and when and where, and to what, and to whom, and how quickly over time can the system recover? And what can we do to either reduce the losses

or speed up recovery, or both, so that the amount of time spent in a state of loss is minimized? We can start with the physical system, that is, the ability to resist or recover from an actual physical disruption. The impacts of that disruption to the economic or social side is critical to keep in mind. It is not just the physical system that needs to recover – the inter-related networks that it supports are also impacted.

Strengthening is important for resilience, so that the infrastructure does not suffer a loss in the first place. Avoidance is also important, such as burying power lines underground. Preparedness also helps with resilience – by prepositioning resources in the run up to a storm, they can be mobilized more quickly. Because of the uncertainty of occurrence (earthquake, landslide, tsunami) and of the impact (hurricane, winter storm) associated with different types of events, the ability to change plans and adapt as needs become more apparent is also critical. Redundancy provides flexibility (with an associated cost), and good connections with neighboring or regional communities can help to facilitate procurement of more or different types of resources.

## Tools to improve resilience

As complex relationships make multi-hazard difficult to plan for, the notion of flexibility is very important. Problem-solving is important in human resources, as is practice – simulated drills, etc. Stress-testing is a useful methodology to capture some of the complexity and to help anticipate not only cascading features in the evolution of a disaster, but also the different impacts on different sectors of society. There is no standard methodology for stress tests, as no systematic scientific basis for them has yet been developed.

The planned capabilities of the smart grid can potentially improve power network resilience by both reducing impacts and speeding recovery: i) reducing cascading impacts through isolation of the impacted portions of the network; and ii) providing the ability for sub-networks to function (possibly at a reduced level) and regulate power usage, even if not connected to the main network. They can be self-healing in the sense that components can also come back online automatically once loads return to standard levels, and they can adapt to the situation, perhaps by shifting to a higher percentage of renewable energy generation, as necessary, to offset other losses. With advances in standards, the support for modularity can also help with bringing emergency power sources quickly online.

Mitigating one disaster can have impacts on others. Mitigation saves. Strengthening a substation against an earthquake can also protect against a landslide or bomb attack. Preemptively shutting down a substation can protect against electrocution and allow for quicker post-flooding recovery. Incre-

mental improvements can have big effects, as demonstrated by cost-benefit analysis.

While early warning, particularly for hydro-meteorological disasters, is considered as key mitigation measure against loss of life and injuries, we doubt that its full potential has been explored for mitigating power supply losses and their adverse impacts.

## Recommendations

Although multi-hazard events that cause or aggravate power systems failures have not been widely observed to date, they do pose a challenge, as they add significant complexity to risk assessment and mitigation strategies. The lack of possibilities to “predict” all conceivable impacts, cascades, and their implications for various societal sectors requires a high degree of adaptability in developing resilience for those systems. This is particularly true if we understand power supply systems as dynamic systems that change characteristics quite rapidly in time.

One cannot predict everything, so one has to be flexible enough to adapt. Some events may be likely, making it easier to focus on and prepare. Scenarios and stress-testing to understand the range of possibilities will allow people and systems to get prepared. We need to better understand multi-hazard events and cascading impacts. Incremental improvements can help to protect against multi-hazard, but there are trade-offs because it may never come to pass. Developing the scientific background around these issues will be very important for understanding cause and effect and implications across the different dimensions of a disaster and fostering the efficiency of operational approaches against adverse impacts.

## References

- “Blackout Hits S. Fla. 4.5 Million Left Without Power”. *Ft. Lauderdale Sun-Sentinel*. May 17, 1985. Retrieved June 1, 2015.
- Cutter, S.L., J. A. Ahearn, B. Amadei, P. Crawford, E. A. Eide, G. E. Galloway, M. F. Goodchild, H. C. Kunreuther, M. Li-Vollmer, M. Schoch-Spana, S. C. Scrimshaw, E. M. Stanley, G. Whitney and M.L. Zoback, 2013. “Disaster Resilience: A National Imperative,” *Environment: Science and Policy for Sustainable Development* 55(2): 25-29.
- Holmukhe, R. M., & Hegde, D. S. (2015). Adoption of Smart-Grid Technologies by Electrical Utilities in India: An Exploratory Study of Issues and Challenges. In *Energy Security and Development* (pp. 231-246). Springer India.
- Farhangi, H. (2010). The path of the smart grid. *Power and Energy Magazine, IEEE*, 8(1), 18-28.
- Garvey, P.R. (2008). *Analytical Methods for Risk Management – A Systems Engineering Perspective*, Chapman & Hall/CRC, ISBN 978-1-58488-637-2.

Golden, T. (1996). Blackout May Be Caution Sign on Road to Utility Deregulation. *The New York Times*. Retrieved from <http://www.nytimes.com/1996/08/19/us/blackout-may-be-caution-sign-on-road-to-utility-deregulation.html?pagewanted=1>

Gonzalez, A. (2011, Aug. 29) Utilities Scramble to Restore Power. *Wall Street Journal*. Retrieved from <http://www.wsj.com/articles/SB10001424053111903352704576536770913696248>

Grünthal, G., Thieken, A. H., Schwarz, J., Radtke, K. S., Smolka, A., Merz, B. (2006): Comparative risk assessments for the city of Cologne, Germany - storms, floods, earthquakes. - *Natural Hazards*, 38, 1-2, p. 21-44.

Kappes MS, Keiler M, von Elverfeldt K, Glade T (2012) Challenges of analysing multi-hazard risk: a review. *Nat Hazards* 64:1925–1958. doi:10.1007/s11069-012-0294-2

Kappenman, J. (2010). *Geomagnetic storms and their impacts on the US power grid*. Metatech.

Kazama, M., & Noda, T. (2012). Damage statistics (Summary of the 2011 off the Pacific Coast of Tohoku Earthquake damage). *Soils and Foundations*, 52 (5), 780-792.

Kinder, L. (2013, October 27). The Great Storm of 1987: What happened 26 years ago. *The Guardian*. Retrieved from <http://www.telegraph.co.uk>

Lee, C. H., & Hsieh, S. C. (2001). A technical review of the power outage on July 29, 1999 in Taiwan. In *Power Engineering Society Winter Meeting, 2001. IEEE* (Vol. 3, pp. 1353-1358).

Marzocchi W, Garcia-Aristizabal A, Gasparini P, Mastellone ML, Di Ruocco A (2012), Basic principles of multi-risk assessment: a case study in Italy. *Nat Hazards*. doi:10.1007/s11069-012-0092-x

Mignan, A., Wiemer, St., and Giardini, D. (2014). The quantification of low-probability-high-consequences events: part I. A generic multi-risk approach, *Nat. Hazards*, DOI 10/1007/s11069-014-1178-4.

National Research Council (1994). Practical lessons from the Loma Prieta earthquake. National Academy Press: Washington D.C., p. 142.

NOAA (2013) This Month in Climate History: 1996 Eastern Washington Ice Storm. National Centers for Environmental Information – News, November 19, 2013. Retrieved from <http://www.ncdc.noaa.gov/news/month-climate-history-1996-eastern-washington-ice-storm>

NOAA (2005) Hurricane Katrina. *National Oceanic and Atmospheric Administration, National Climatic Data Center*. Retrieved from <http://www.ncdc.noaa.gov/extremeevents/specialreports/Hurricane-Katrina.pdf>

“Resilience Lessons: Orion’s 2010 and 2011 Earthquake Experience” (2011). Kestrel Group Ltd. Retrieved from [http://www.oriongroup.co.nz/downloads/Kestrel\\_report\\_resilience\\_lessons.pdf](http://www.oriongroup.co.nz/downloads/Kestrel_report_resilience_lessons.pdf)

“Sandy’s Impacts State by State: Millions Without Power, More Than 50 Dead.” *WITN*. October 31, 2012. Retrieved from <http://www.witn.com/home/headlines/Sandys-Impacts-State-By-State-Millions-Without-Power-More-Than-50-Dead-176557611.html>

Schmidt, J., Matcham, I., Reese, S., King, A., Bell, R., Henderson, R., Smart, G., Cousins, J., Smith, W., Heron, D., Quantitative multi-risk analysis for natural hazards: a framework for multi-risk modelling, *Nat Hazards* (2011) 58:1169–1192 DOI 10.1007/s11069-011-9721-z

Tatge, J. (2009) Looking Back, Looking Forward: Anatol, Lothar and Martin Ten Years Later. *Air-Worldwide*. Retrieved from <http://www.air-worldwide.com/Publications/AIR-Currents/Looking-Back,-Looking-Forward--Anatol,-Lothar-and-Martin-Ten-Years-Later/>

USDOE (2005) Hurricane Katrina Situation Report #42. *U.S. Department of Energy, Office of Electricity Delivery and Energy Reliability (OE)*. Retrieved from [https://www.oe.netl.doe.gov/docs/katrina/katrina\\_092305%20\\_1500.pdf](https://www.oe.netl.doe.gov/docs/katrina/katrina_092305%20_1500.pdf)

## 1.4. Electricity supply security, service valuation, and public perception of energy infrastructure

Johannes Reichl, Jed Cohen, Klaus Moeltner and Michael Schidthaler,

Energieinstitut an der Johannes Kepler Universität Linz, Austria and Dept. of Agricultural and Applied Economics, Virginia Tech, Blacksburg, USA

### Abstract

This contribution investigates the socio-economic relevance of electricity supply security, and some challenges to maintaining the current level of reliability in Europe. Thus, firstly, historic evidence of large-scale power interruptions are presented and their socio-economic ramifications are discussed. Secondly, a newly developed analysis tool, blackout-simulator.com, which assesses the social consequences and economic damage from power outages in the European Union (EU) up to now, is presented. This open access analysis model allows, for the first time, an evaluation of the effects of user-specified power interruptions at a fine scale, both geographically (266 Nuts-II regions at state level for 27 EU member states), and for all sectors of the economy and households (10 customer groups in total). This section also contains a damage assessment of the September 2003 blackout in Italy. Thirdly, this contribution contains the first trans-European evidence as to how infrastructure projects such as power grid expansions are seen by the public, and what factors influence these public perceptions. The empirical analysis conducted finds, for instance, that while *a priori* opposition to new grids exists at different degrees across EU member states, auxiliary information regarding the positive effects of a grid development project can have a substantial impact in terms of decreasing the opposition of local stakeholders. This knowledge is paramount in being able to support required energy infrastructures and to ensure a reliable power supply in the future.

### 1. Introduction

For highly specialized societies in Europe, a reliable electricity supply is more than an amenity and an input factor for productive processes. This is reflected by substantial societal vulnerabilities in the case of a power interruption and by the

Table 4. Overview of historic power interruptions, their dimension and their origin

Date	Country	People Affected	Origin
Mar 2015	Turkey	70,000,000	Technical problem at transmission level
Jan 2015	Pakistan	140,000,000	Militant attack
Jul 2012	India	620,000,000	Overload
Feb 2008	USA (Florida)	6,000,000	Transformer station
Jul 2007	Germany (Düsseldorf)	150,000	
Jul 2007	Spain (Barcelona)	350,000	Defective switchgear
Jul 2007	Georgian Republic (Tiflis)	1,100,000	
Nov 2006	Germany/NW Europe	10,000,000	Switching error at high voltage-level
Nov 2005	Germany (Münsterland)	250,000	Buckling pylons
Jun 2005	Switzerland	200,000	Error in railway grid
May 2005	Russia (Moscow)	2,000,000	
Nov 2004	Spain	2,000,000	Fire in transformer station
Sep 2004	Germany (Rheinland-Pfalz)	1,000,000	Short-circuit
Dec 2003	Germany (Gütersloh)	300,000	Sabotage
Sep 2003	Sweden / Denmark	4,000,000	Switching error
Sep 2003	Italy	56,000,000	Breakdown of high-voltage line
Aug 2003	USA / Canada	50,000,000	Computer error / ageing grid
Aug 2003	UK (London)	1,000,000	Wrong safety device
Jun 2003	Italy	6,000,000	Insufficient KW-capacity
Jan 2001	India (New Delhi)	200,000,000	
Dec 1999	France	3,400,000	Hurricane "Lothar"
Dec 1995	USA (Oregon)	2,000,000	Storm
Jul 1977	USA (New York)		Lightning strike
Nov 1965	USA / Canada	25,000,000	

Source: RWTH Aachen, Verivox, Spiegel, primary research

evidenced level of personal discomfort resulting from power outages. Public attention in this regard has increased in past years, which has brought about a plethora of research dedicated to this topic.

This contribution summarizes recent evidence on the importance of electricity supply security, both economically and socially; it also provides an overview of the societal challenges associated with maintaining the current level of reliability. We first elaborate the dimension and consequences of actual power outages, then evaluate the public perception of energy infrastructures such as power grids.

## 1. Socio-economic dimension of power outages

One reason for the increasing public and scientific attention to electricity supply security is rooted in the experiences of adverse effects to society from actual power outages. For instance, within a couple of weeks in 2003, a series of blackouts left over 110 million people in Italy, Sweden, Denmark, UK, Canada, and the USA without electricity (Bialek 2004). Not

only did social and economic life come to a stop for up to 24 hours, but because of the large-scale incidents, hundreds of thousands were stranded as private and public traffic collapsed, and had to spend the night far from their homes. As another example, Detroit had to ban the drinking of municipal tap water for 72 hours after the restoration of power following a blackout. The threat of epidemic reached a critical level after water pipes could not be rinsed during the blackout, leading to further critical situations, for example, in the medical system (Klein et al. 2005). Thus, it is important to be aware of the scope and damage categories of power outages, especially for long-term planning of the required infrastructures. Table 5 provides an overview of various historic blackouts and highlights their technical or human-induced causes. Only when the origins of power outages are considered in the course of developing countermeasures, can protection against cascading effects and other malfunctioning be developed and the proper functioning of critical infrastructures assured.

The consequences of cascading effects are especially devastating, as evidenced by the Italian blackout of 28 September

Table 5. Summary of historic power outages

Country & year	Social impacts		
	Number of end-users interrupted	Duration, energy not supplied	Estimated costs to whole society
Sweden/Denmark, 2003	0.86 million in Sweden and 2.4 million in Denmark	2.1 hours, 18 GWh	€145-180 m
France, 1999	1.4-3.5 million, 193 million m <sup>3</sup> wood damaged	2 days -2 weeks, 400 GWh	€11.5 bn
Italy/Switzerland 2003	55 million	18 hours	
Sweden, 2005	0.7 million, 70 million m <sup>3</sup> wood damaged	1 day-5 weeks, 111 GWh	€400 m
Central Europe 2006	15 million households	Less than 2 hours	

Source: Bompard et al. 2011

2003. Triggered by smaller incidents at different parts of the power interconnections with neighboring countries, this outage finally affected 56 million Italian citizens. It is a vivid example of current vulnerability and preparedness patterns. For this and other reasons, this power outage has been intensively researched. The investigation of blackout characteristics helps shed a light on the societal importance of power supplies. Bompard et al. (2011), for instance, compares the Italian blackout with – in total – 34 blackouts (of which an excerpt for Europe is provided in Table 6). The estimated costs, the amount of energy not supplied, and the number of interrupted end-users are discussed in detail.

This summary of various outage characteristics highlights the correlation between the scope of blackouts and the number of residents affected. In addition, an estimate is given with regards to the macroeconomic costs of these power interruptions. However, for a holistic analysis of electricity supply security, various additional damage categories ought to be accounted for. Thus, personal effects, such as stress, mistrust, and other utility losses need to be taken into consideration. In addition to personal effects, the inclusion of business damages is paramount. Even the location choices of businesses are affected by the prevailing level of supply security. Finally, the knowledge of the value of electricity supply security is particularly relevant, as infrastructure investment costs in particular need to be counterbalanced by quantifiable monetary infrastructure benefits.

To provide sound quantifications of the value of supply security, the European FP7 project SESAME<sup>2</sup> conducted a thorough investigation of the socio-economic dimension of large power interruptions. This led to the development of the – open access – analysis tool blackout-simulator.com, which

allows an efficient estimation of the ramifications of power outages for all European provinces. The next section briefly shows how objective measurements of the costs of power interruptions can be conducted and highlights how the presented model can be used to elicit the ad hoc costs of power outages.

## 2. Economic dimension of power outages

Decisions to invest in or maintain the current transmission and distribution infrastructure rely on scientific assessments of the economic worth of supply security.

While developing the necessary measures to enhance supply security is mainly a challenge to the engineering disciplines, it is the task of economic research to support the development of a system of incentives to counterbalance possible market failures. Obviously, supply security constitutes a non-market good and can be purchased only in combination with the product (electricity). Thus the value of supply security cannot be determined directly. That is why the failure of electricity supply, and in particular the costs occurring when electric power cannot be accessed, are usually used to assess the value of supply security (Baarsma and Hop 2009; de Nooij et al. 2007). Generally, the economic costs of power outages can be divided into three categories (Munasinghe and Sanghvi 1988): (i) direct costs, (ii) indirect costs, and (iii) resulting long-term costs of macroeconomic relevance. While in the public eye direct economic losses are typically at the top of the list, they are usually subordinate to indirect economic losses. Indirect costs also arise as a consequence of power outages, yet they belong to that part of the total losses resulting from the absence of electricity supply in the aftermath of the power cut, which includes the cost of production outages or lost value added due to inputs or logistics being unavailable (Centolella, 2006).

<sup>2</sup> Sesame is a FP7-security project co-funded by the European Commission under grant number 261696, aiming to provide a contribution to the development of tools and a regulation framework for the security of the European power grid against natural, accidental, and malicious attacks. <https://www.sesame-project.eu>. The views expressed herein are those of the SESAME consortium and can therefore in no way be taken to reflect the official position of the European Commission.

Table 6. WTP increasing factors for European households to avoid power cuts

Variable	WTP Increase compared to mean of entire sample
Belonging to country's highest 20% income group	8.6%
Children below 14 in household	4.4%
Spare time is affected	14.6%
Whole country is affected (instead of residential street only)	32.7 %

blackout-simulator.com takes these into account and combines direct and proxy measurements with a third assessment category – contingent valuation methods (CVM) – which forms the cornerstone of the evaluation of household damages. CVM permit the valuation of power outage-related losses incurred from the customers' perspective (Reichl et al., 2013). Thus, the model includes 8,336 interviewees from all EU member states (at least 250 in each country) to evaluate the willingness of households to pay (WTP) to avoid power outages. The chosen sample of survey participants is considered representative of the European population. Results were checked for consistency. For instance, households typically show higher WTP to prevent (geographically) larger interruptions compared to outages, which affect only their neighborhood.<sup>3</sup>

Importantly, the season in which a power interruption occurs is found to significantly influence the damages assigned to an outage. European households have a significantly lower WTP to prevent an outage in the summer than during the winter. This can be explained by lower dependence on electricity for lighting and the fact that crucial services such as heating are likely to be primarily affected during the winter season.<sup>4</sup> Table 7 presents a summary of influencing factors with respect to the valuation of supply security. It should be interpreted in the following way: if a household belongs to the 20% highest income group, then this household is – on average – willing to pay 8.6% more to avoid a power outage than the average household in the European Union. The same applies to the other variables.

To summarize, the combination of household and non-household modeling approaches allows blackout-simulator.com to assess 266 (of the original 271) Nuts 2 regions in the European Union. In total, nine economic sectors, as well as households, are incorporated into the analysis. This high level of detail is important, especially if results are utilized in regional infrastructure planning, regulation, and energy policy. Thus, blackout-simulator.com can assess various outages with different properties. The database was designed to control for the outages' and residents' properties, such

as season and time of an outage, household characteristics such as level of education, degree of urbanization, previous blackout experience, age and household income, as well as the geographical extent of the outage. An application of this tool is presented subsequently.

### 2.1. Demonstration of blackout-simulator.com – Assessment of September 2003 power outage in Italy

A prominent example of a large power outage in Europe occurred on 28 September 2003 in Italy. The outage was due to a series of transmission failures and subsequently affected all of Italy (except Sardinia). Figure 10 and Table 8 show the extent of this power outage and the average time needed to fully restore the electric power supply to different parts of the country. The economic losses are modeled for the period from 3am until full recovery. The total duration was 3 hours in the north, 9 hours in the center, 12 hours in the south, and 16 hours in Sicily. Figure 10 also depicts the characteristics of this outage scenario. In blackout-simulator.com, the affected areas are selected by means of an interactive map function.

The economic losses and effects due to this power outage are presented in Figure 10. The damage to businesses is calculated at €897.5 million. Households' change of utility, both material and non-material amounted to €285 million. This substantial damage corresponds to .08% of the annual Italian GDP.

*All damages to the different NACE sectors are reported in million (m) €.*

The results were compared with other relevant studies, such as an assessment by a dedicated board of Italian experts and scientists (Commissione di Indagine, 2003) which found the outage caused costs of approximately €640 million and a loss of load of 160 MWh. While this only takes into account non-household damages, it only marginally deviates from the damages of businesses and the public sector calculated using **blackout-simulator.com** as given in Table 8. Figure 11 presents a summary of the power outage assessment with **blackout-simulator.com** and its intuitive assessment procedure.

As shown, blackout-simulator.com provides an intuitive<sup>5</sup> and rational means of evaluating the value of electricity supply

<sup>3</sup> In absolute terms WTP to prevent a five-hour power outage affecting the entire country increases from €4.4 to €5.9 on average across all 27 member states in the European Union (2012) when compared to smaller blackouts.

<sup>4</sup> The WTP of European households in this case on average decreases from €4.4 (winter) to €2.9 (summer).

<sup>5</sup> Depending on the desired level of detail, the elicitation of power outages is now a matter of about two minutes and five to ten mouse clicks.

Figure 10: Evaluation of the power outage in Italy on 28 September 2003

<b>Date of start of outage</b>	<b>28 September 2003</b>
Start time of outage	03:00 am
Duration in hours	3-16h depending on the region
Provinces affected	Italy (except Sardinia)
Public holiday	Yes (Sunday)



Table 7. Total losses across all regions and sectors; summary of blackout-simulator.com

	Primary sector	Secondary sector	Tertiary sector	Total losses	WTP Households	Total losses in region
Region North	5.3	136.7	60.8	202.8	43.0	245.8
Region Center	20.6	217.6	154.6	392.8	98.2	491.0
Region South	20.9	82.8	97.5	201.2	94.3	295.5
Region Sicily	12.4	33.7	54.6	100.7	49.5	150.2
<b>Total</b>	<b>59.2</b>	<b>470.8</b>	<b>367.5</b>	<b>897.5</b>	<b>285.0</b>	<b>1182.5</b>
<b>% of GDP</b>	0.004%	0.031%	0.025%	0.060%	0.019%	0.079%

stability-enhancing investments and other energy policy decisions. In making this tool available for the broader public, the model allows the economic valuation of supply security on the basis of blackout costs for companies, institutions, and households' willingness to pay (WTP). For its development, an unprecedented survey incorporating over 8,300 households in all EU member states was conducted. In the light of the presented – substantial – value of electricity supply security, measures to secure this amenity have gained increasing public attention. In this regard, social factors such as the perception of grid developments are highly important to ensure a smooth interaction with the public when investing in a secure network infrastructure of the future. The following section thus presents a novel assessment approach making use of a trans-European quantitative framework, which has recently become available.

### 3. Social perception of electricity infrastructures

The challenge to maintain high levels of reliability will require an adaptation and modernization of energy infrastructures. Furthermore, the current European Union vision for a low-carbon electricity system requires the large-scale expansion of overhead transmission lines to integrate renewable energy sources (RES) while ensuring a secure electricity

supply for the future. However, especially in the recent past, new installations – for instance, of overhead transmission lines – across Europe have been stymied by local opposition which causes long delays in project completion and occasional cancellations. However, the implementation of renewable electricity sources in particular hinge on increased grid connectivity (ENTSO-E, 2012). To overcome this dilemma, knowledge of the public perceptions of infrastructures and the influential factors of such perceptions is paramount. This is the case not only for the electricity system.

To this end Cohen et al. (2016) present the first empirical assessment of the social acceptance of electricity infrastructures with a focus on transmission lines. They find substantial differences across Europe, with a strong tendency of locals to initially oppose nearby grid development in the Western European countries, and a more welcoming view in the new (Eastern) EU member states. In many cases, the resistance against power infrastructure is understandable from a personal perspective, yet a profound assessment of this problem has so far been missing. The importance of taking into account these perception patterns has nevertheless been acknowledged. For instance, a recent ENTSO-E report states, with respect to grid enhancement, that “overall, there has been material delay to the delivery of one third of the investments, mostly because of social resistance” (ENTSO-E,



# Blackout example Italy

- Blackout on September 28<sup>th</sup> 2003
- 3 hours north, 9 hours center, 12 hours south, and 16 hours in Sicily
- Consumer behaviour: measured load profiles



Blackout region and time

Date: 28.09.2003 from 3 o'clock

Duration: 3 hours

Regions: ITC2 Valle d'Aosta/Vallée d'Aoste  
ITD2 Provincia Autonoma di Trento  
ITD4 Friuli-Venezia Giulia  
ITC4 Lombardia  
ITC1 Piemonte  
ITD1 Provincia Autonoma di Bolzano/Bozen  
ITD3 Veneto  
ITC3 Liguria



Blackout region and time

Date: 28.09.2003 from 3 o'clock

Duration: 9 hours

Regions: ITD5 Emilia-Romagna  
ITE1 Toscana  
ITE2 Umbria  
ITE3 Marche  
ITF1 Abruzzo  
ITE4 Lazio



Blackout region and time

Date: 28.09.2003 from 3 o'clock

Duration: 12 hours

Regions: ITF2 Molise  
ITF3 Campania  
ITF4 Puglia  
ITF5 Basilicata  
ITF6 Calabria



Blackout region and time

Date: 28.09.2003 from 3 o'clock

Duration: 16 hours

Regions: ITG1 Sicilia



Add blackout region any time

Damage costs: 1,182.44 million Euro\*

\*Results are adjusted for inflation.

Figure 11. Implementation of the assessed power outage in Italy on 28<sup>th</sup> September 2003 using blackout-simulator.com (own depiction).

**Legend**

**Proportion of DNA responses**

- out of sample
- 0-22
- 22-32
- 32-42
- 42-51

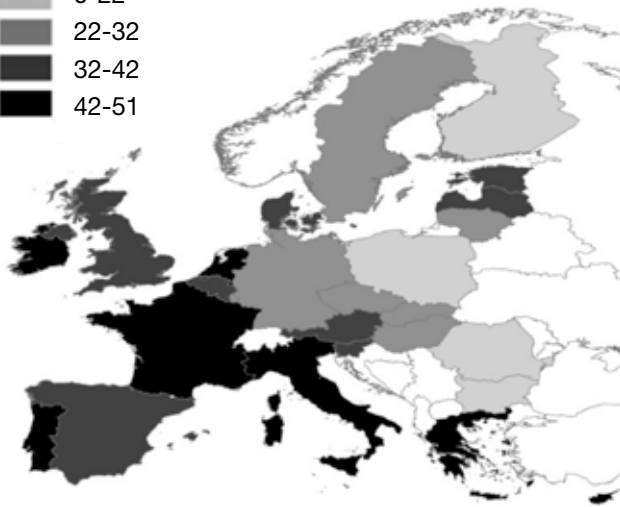

**Figure 12. Social acceptance of power infrastructure and grids in Europe**

Source: Cohen et al. 2016

2012). The tendency whereby a general acceptance – namely, of the transition towards a low-carbon society – meets resistance for nearby, yet necessary, development is often referred to as a “not-in-my-backyard,” or NIMBY issue. An analysis of this “NIMBY-Status-Quo”<sup>6</sup> as provided by Cohen et al. (2016) is presented in Figure 12. This depicts the general perception of electricity networks being built 250 m from the home of surveyed residents.

The fact that Western European countries tend to exhibit greater tendencies to reject energy infrastructures is clearly visible. Apart from this analysis of the Status-Quo, Cohen et al. (2016) also provide an assessment of the effects of information regarding an infrastructure project’s advantages. Interestingly, a strong effect of upfront information campaigns is found. As soon as locals are informed that power lines will have a positive economic or environmental impact, these projects will generally meet less resistance than those having only compensatory benefits to the community (e.g., building public infrastructure). In particular, emphasizing any long-term carbon reduction potential or economic benefit of a particular project will, on average, decrease the likelihood that a locality is strongly opposed to the project by 10-11%. The relative effects of different information campaigns are displayed in Figure 13.

It can therefore be concluded that, in fact, it does matter what kind of information regarding the – possibly – posi-

<sup>6</sup> In particular, this concerns the share of residents who strictly oppose the presented development. In this regards DNA corresponds to “Definitely not accept” as shown in the figure.

**Economic Benefits Treatment (T1)**



**Environmental Benefits Treatment (T2)**

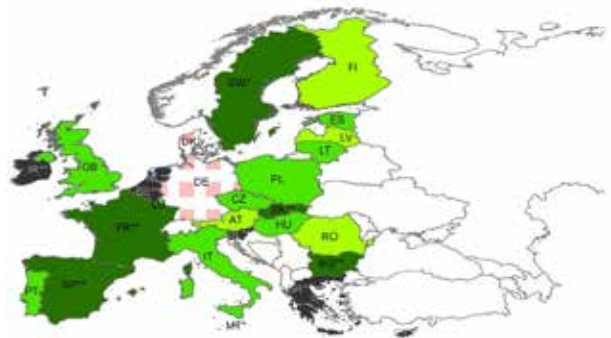

**Community Benefits Treatment (T3)**



**Legend**

**Marginal Effect (%)**

- >20
- 10-20
- 5-10
- 0-5
- <0

**Figure 13. Evaluation of perception-changing information campaigns**

Source: Cohen et al., 2016

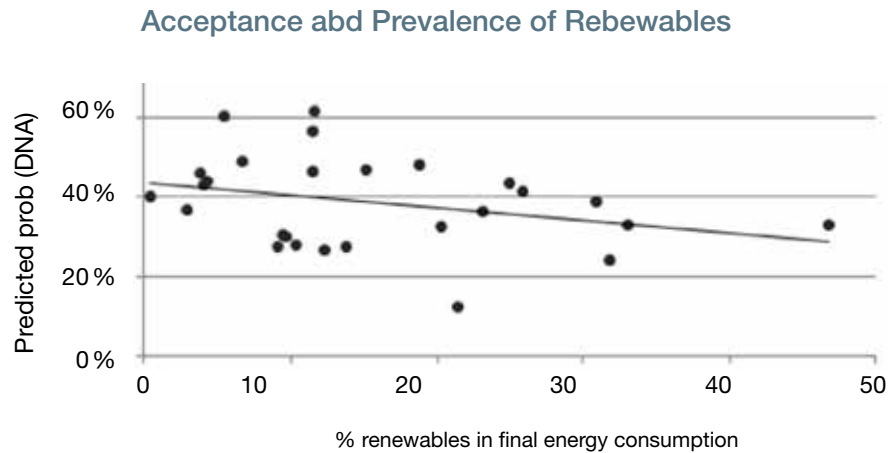

**Figure 14. Acceptance of energy infrastructures and share of renewable energy utilization**

Source: Cohen et al. 2016

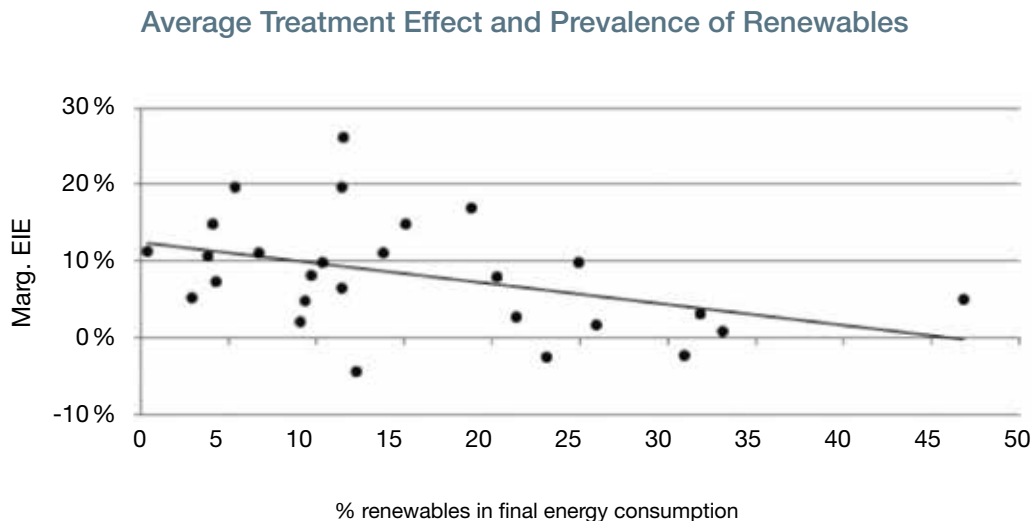

**Figure 15. Average effects of information campaigns vis-a-vis renewable energy presence.**

Source: Cohen et al. 2016

tive effects of a certain infrastructure project are transmitted to residents. This is very important for project managers to know so that they can adapt and plan their information strategy accordingly.

Overall, the results show that if the positive benefits of a proposed energy infrastructure can be presented to locals, acceptance of a project raises substantially. The strong positive effect on acceptance induced by two out of three benefit packages suggests that many locals can overcome NIMBY sentiments when presented with the proper information.

In addition to the country-specific analysis, particular attention has been paid to the effects and prevalence of electricity greening strategies. Recent findings dwell upon the fact that the national use of renewable energy sources (RES) influences both acceptance levels and the efficacy of treatment effects to change a potentially negative (i.e., rejecting) precondition.

Figure 14 shows that the larger the proportion of RES in final energy consumption, the lower the chance of outright opposition to new grid projects (Cohen et al. 2016).

The same is the case for the efficacy of information campaigns. When compared and correlated to the share of RES, they are found to have less – positive – effect.

The summarize, the data suggest that if renewable sources are already heavily used, the likelihood of immediate rejection is reduced, but also that information campaigns have less of an effect once residents are strictly against an energy infrastructure project. More generally, research on social acceptance of electricity networks has shed light on the driving factors behind people's perceptions regarding new infrastructures. The empirically rooted results emphasize the need for developers to tailor their acceptance strategies to the specification of projects and the special situation of nearby residents. As

already discussed by Cohen et al. (2014), the development of nearby energy infrastructure incurs a real cost to local stakeholders; thus, acceptance strategies should be focused on facilitating quick and efficient negotiations between locals and infrastructure developers, and not on ignoring the claims of locals.

This contribution shows which information strategies will have the largest positive effect in terms of reducing outright opposition, which would make reaching a compromise with local residents difficult. This is available for each country in the European Union separately and enables project managers to tailor specific information campaigns with particular features. Thus, for instance, any economic ramifications of new transmission lines should be flagged in France and Spain, whereas any benefits to the environment should be the focus in the Netherlands and Belgium.

## 4. Summary

The supply of electricity is considered highly reliable in Europe. However, maintaining this degree of reliability in the future involves a number of challenges. Despite high levels of supply security, large scale interruptions – which are shown to occur even in Europe – bring about substantial challenges for societies, businesses, and every individual.

Efficient decisions regarding investment in energy infrastructures are possible only if the value of electricity supply security to households and businesses can be determined. To obtain a holistic valuation of supply security, a model-based approach is presented: [blackout-simulator.com](http://blackout-simulator.com). This includes precise information from over 8,300 European households and accounts for damages to businesses, administration, and public institutions using a split accounting approach.

As a result, not only particularly vulnerable sectors, such as the semiconductor industry, papermaking, or data-generating processes, but all branches of the economy (NACE 2008 economic classification) can be modeled. It is thus possible for the first time to judge subsectors of the European economy province by province with respect to their degree of dependence on a reliable supply of electricity.

This contribution contains a demonstration of this tool, which analyzes the effects of the 2003 power outage in Italy affecting over 55 million people. It lasted for three hours in the north, nine hours in the center of Italy, 12 hours in the south, and up to 16 hours in Sicily. The macroeconomic damage of this power outage in its entirety was calculated to be €1.18 billion (in 2003 €). The level of detail is unprecedented and includes economic damage data for every sector and for households (€897.5 million and € 285.0 million, respectively).

Finally, a presentation of the public perception of power infrastructures highlights the differences among European countries and presents opportunities to support appropriate information campaigns. It was found that environmental and economic advantages should be presented in most of the EU member states in order to bring affected – and mainly opposing – residents to the table for further discussions and explanations of a project's specifications. Generally, however, although energy infrastructures are regarded as necessary, the challenge of social acceptance is among the main causes of big delays in European grid infrastructures. Using novel evidence, this can now be addressed and best-practice information campaigns can thus be developed based on country-specific preference structures.

## References

- Baarsma, B. E., & Hop, J. P. (2009). Pricing power outages in the Netherlands. *Energy*, 34 (9), 1378-1386.
- Bialek, J. W. (2004). *Recent Blackouts in US and Continental Europe: Is Liberalisation to Blame?*
- Bompard, E., Huang, T., Tenconi, A., Wu, Y., Zelastiba, D., Cremenescu, M., et al. (2011). *Securing the European Electricity Supply Against Malicious and accidental threats*.
- Centolella, P. a.-D. (2006). *Estimates of the Value of Uninterrupted Service for The Mid-West Independent System Operator*. Tech. rep., SAIC.
- Cohen, J., Moeltner, K., Reichl, J., & Schmidthaler, M. (2016). An Empirical Analysis of Local Opposition to New Transmission Lines Across the EU-27. *The Energy Journal*, 37 (3), 59-82.
- Cohen, J., Reichl, J., & Schmidthaler, M. (2014). Re-focussing research efforts on the public acceptance of energy infrastructure: A critical review. *Energy* (76), pp. 4-9.
- de Nooij, M., Koopmans, C., & Bijvoet, C. (2007). The value of supply security. The costs of power interruptions: Economic input for damage reduction and investment. *Energy Economics*, 29, 277-295.
- ENTSO-E. (2012). *Ten year network development plan 2012*.
- Klein, K. R., Rosenthal, M. S., & Klausner, H. A. (2005). *Blackout2003: Preparedness and Lessons Learned from the Perspective of Four Hospitals*.
- Munasinghe, M., & Sanghvi, A. (1988). Reliability of Electricity Supply, Outage Costs and Value of Service: An Overview. *IAEA Special Issue Electricity Reliability Issue* (9).
- Reichl, J., Kollmann, A., Tichler, R., & Schneider, F. (2008). The importance of incorporating reliability of supply criteria in a regulatory system of electricity distribution: An empirical analysis for Austria. *Energy Policy*, 36 (10), 3862-3871.

## 5. Appendix

### 1.1. Economic Sectors

Based on data availability we determined nine economic sectors, which are based on the NACE Rev. 2 System.

- (A) Agriculture, forestry and fishing
- (B,D,E) Mining and quarrying;

Electricity, gas, steam and air conditioning supply;  
Water supply, sewerage, waste management and remediation activities

- (C) Manufacturing
- (F) Construction
- (G,H,I) Wholesale and retail trade, repair of motor vehicles and motorcycles;

Transporting and storage;

Accommodation and food service activities

- (J) Information and communication
- (K) Financial and insurance activities
- (L,M,N) Real estate activities;

Professional, scientific and technical activities;

Administrative and support service activities

- (O,P,Q,R) Public administration and defence, compulsory social security;

Education;

Human health and social work activities;

Arts, entertainment, and recreation



Figure 16. The future renewables-based power system in Europe requires new interconnections to transmit renewable electricity from remote generation sites to consumption centers and storage sites.

Source: Germanwatch 2015

## 1.5. Transition to a renewables-based power system: Why public participation has an important role to play in power grid planning

Rotraud Haenlein, Germanwatch

### Summary

An upgrade of the European electricity infrastructure is crucial for the future renewables-based low-carbon power system that will ensure energy security and sustainability. We see more and more evidence that a power system based on fluctuating energy sources such as wind and solar can provide a secure, low-carbon supply even in a highly industrialized Europe. But at the same time, these new renewable energy sources pose a challenge in terms of network integration. At the same time, transmission grid projects have turned out to be at the center of the public debate on the local level.

Enhanced stakeholder engagement, public dialogue on corridor finding and technology, and a transparent planning procedure based on high environmental standards may help overcome public concerns about new transmission grid projects. Several European transmission grid operators (TSOs) have tested different innovative approaches to achieve early cooperation with environmental groups and to involve the public at a very early stage in the planning procedure. Their experience shows that it is worth cooperating early with local stakeholders. At the same time, this remains a field of continuous learning.

### Power grids of the future

Power grids form an integral part of energy transition in Europe and have an important role to play in the future European low-carbon power system based on renewables (Balke 2014). They are cost- and energy-efficient compared to other infrastructure options such as storage technology. More and smarter power grids can help balance fluctuations in renewable energy supplies. Therefore, the upgrade of European power grids is an important part of restructuring our energy system.

In the context of this ongoing transition, we are facing both technical and social challenges. Often, when large transmission lines are being planned or constructed there are local protests. Those conflicts should be addressed through early and meaningful participation with affected communities and other stakeholders. This article outlines general principles for meaningful public participation with reference to experiences from the European BESTGRID project. Within this project, five European TSOs have closely cooperated with environmental NGOs and over the period 2013-2015 have tested different approaches of early cooperation with civil society stakeholders in Belgium, the UK, Italy, and Germany. Other examples throughout Europe support their learning that early stakeholder engagement may help in finding planning options that have better local acceptance (Sander et al. 2012).

<b>Needs assessment</b> Level 1		<b>Corridor / route planning</b> Level 2 (a two-step procedure in some countries)		<b>Construction and operation</b>
<b>Scenarios</b>	<b>Grid development plan</b>	<b>Corridors</b>	<b>Detailed routes</b>	<b>Construction and operation</b>
Scenario development EU / national	Grid or network development plans EU (TYNDP) / national	Corridors	Detailed determination of routes	
What are the likely future developments of electricity generation and demand?	What projects are needed?	In which corridor should the power line be built?	Which route should be determined in detail? Where will pylons (or cables) be built?	
		Spatial planning	Corridor and route planning	

Figure 17. Planning procedure for transmission lines

Source: Germanwatch, based on Bundesnetzagentur 2015

## Transparent planning procedure

Planning a power grid is highly complex, making it difficult for transmission system operators (TSOs) to provide clear and useful background information. Most people would not want to read long reports or consult numerous studies and other documents. Also, different stakeholders will want different information: experts might want to know about complex technical issues, while non-expert local residents might want easily understood information that is relevant to their communities.

The relevant authorities, as well as the TSOs, must take responsibility for providing information early in the planning process to experts and others interested in being consulted. Those responsible for grid planning should make use of all means of communication to reach broader audiences and provide different types of information. They need to communicate clearly how the power grid planning procedure works in the respective country. A key condition of an open, transparent planning process is that all concerned understand the structure of the planning procedure and know the major players with legal planning responsibility in power grid planning.

## Early participation in corridor finding procedure

Transmission system operators wishing to develop an innovative and participatory approach to power grid planning will ask themselves at an early stage of the process:

- Who should be involved, when and how?
- What level of participation is appropriate and feasible at which stage of the planning process?

To answer these questions, two planning levels – **needs assessment** and **corridor and route planning**, as shown in Figure 17 – should be analyzed separately from each other.

At both planning levels, public participation might follow a five-step approach (Rottmann 2015):

1. A thorough and diligent stakeholder analysis (“stakeholder mapping”)
2. A tailor-made and transparent public participation strategy to be used during the needs assessment or for a specific project
3. Sound implementation and execution of the participation strategy
4. Presentation and discussion of the outcome of public consultations, including room for feedback from the stakeholders concerned
5. Evaluation of the public participation strategy

In addition to these general guidelines for effective participation, TSOs will also need to develop strategies that relate to the interests expressed by stakeholders concerned with a specific power line project.

## Options for and limits to public participation in power grid planning

Stakeholders engaging in planning processes often have high expectations about the outcome. To avoid disappointment, grid planners and operators need to clearly explain what they mean by participation.

Until now, public participation in the grid planning process has usually been limited to the first two levels of participa-

tion.<sup>7</sup> This is because planning a power grid requires expert knowledge in a range of fields, including energy economics, electrical engineering, planning law, and nature protection law, to name a few. Power grid and energy experts thus take the final decisions related to the needs assessment. These experts may include “trusted experts” from different stakeholder groups, but in addition, local knowledge needs to be taken into account by these experts. However, public participation may go further in the corridor planning process and involve some form of co-decision making (third step on the “ladder of participation” shown in Figure 18). There are good opportunities for public participation in power grid planning at the level of information and consultation. Public participation can be extended to the level of co-decision, especially when it comes to determining corridors and routes.

Grid operators, politicians, and public authorities have gone beyond the formal requirements and extended their scope of engagement by organizing informal information and dialogue events at an early stage of the planning. There are various reasons for this: first, early engagement can contribute to finding more suitable planning options. Second, identifying the concerns and needs of local and environmental stakeholders at an early stage helps to more effectively determine local mitigating measures. Finally, various stakeholder groups have expressed their dissatisfaction that legally required planning procedures do not take their interests sufficiently into account.

There is still much more to do: ways should be sought how best to incorporate the conclusions of informal dialogues, in which concerns raised by locals and other relevant stakeholders are discussed, into the formal planning procedure.<sup>8</sup>

## Stakeholder interests and public concerns

A broad range of stakeholders may be directly or indirectly affected by a power line project. Their legitimate yet sometimes conflicting interests and arguments need to be taken into account and carefully balanced during the planning process. There are, however, various public concerns, which are, from the point of view of numerous local stakeholders, not sufficiently addressed within the formal planning procedure:

- **Landscape:** New power lines and new power generating facilities, like wind turbines, change the appearance of familiar landscapes. Local residents, tourists, or people

<sup>7</sup> With reference to the “Arnstein ladder of participation”: Sociologists suggest that public participation can be divided into four levels, ranging from pure information to self-governance. Arnstein, Sherry R (1969). A Ladder of Citizen Participation. JAIP, Vol. 35, No. 4, 216-224. [www.lithgow-schmidt.dk/sherry-arnstein/ladder-of-citizen-participation.html](http://www.lithgow-schmidt.dk/sherry-arnstein/ladder-of-citizen-participation.html). Rau, I, Schweizer-Ries, P & Hildebrand, J (2012). Participation Strategies: The Silver Bullet for Public Acceptance? In: Kabisch, S et al: Vulnerability, Risk and Complexity: Impacts of Global Change on Human Habitats, Leipzig, 177-192.

<sup>8</sup> Further information on the options for participation within formal and informal planning procedures in European, German, and UK legislation can be found in Harrison K and Verheyen R (2015, in press). Opportunities and Restrictions for Public Participation in European Transmission Grid Projects ([www.germanwatch.org](http://www.germanwatch.org)).

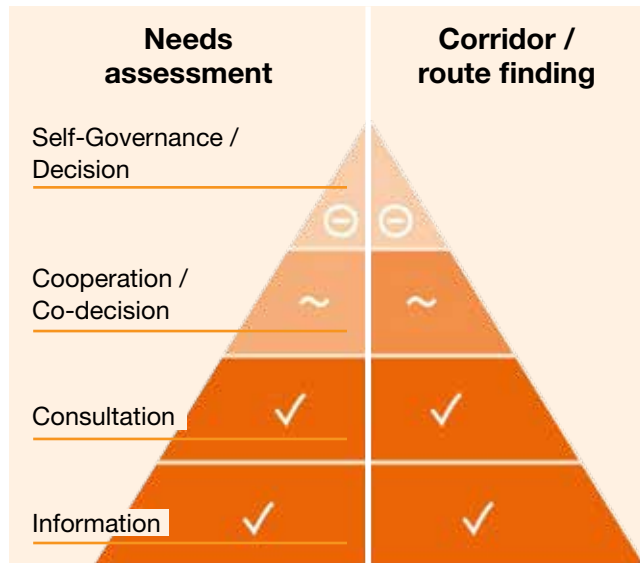

Figure 18. Public participation levels in power grid planning

Source: Germanwatch: based on Arnstein (1969) and Rau et al. (2012)

who love a particular landscape may feel strongly about their area and thus oppose a project they feel will negatively impact on the environment, landscape, or residential areas. Concerns about impacts on landscapes and nature may add to public pressure that aims to prevent projects going ahead. Grid operators often struggle with addressing the interests and heightened emotions of concerned residents during the corridor planning process. They have to take account of various legitimate and legally protected goods and interests, including property law, nature and conservation regulation, and emission control legislation. Landscape protection is, in some countries, part of nature conservation law, but in a large number of countries, the law does not sufficiently protect the legitimate interests of stakeholders such as tourist associations and local residents. As a result, little or no attention is paid to their concerns about protecting their surrounding landscapes during the formal planning procedure. Similarly, no regulation has been enacted to require that power lines be built far from residential areas. Any such attempt, however, may prove challenging, given that within such a legal framework no new power line could be built in densely populated countries, for example, Belgium.

- **Concerns related to electromagnetic fields (EMF):** In spite of national exposure limits based on scientific knowledge, public concerns about the possible health impacts of magnetic fields surrounding power lines have not been sufficiently overcome by international research. Certain health issues remain a concern. For one, the question as to whether EMF exposure might have additional adverse impacts has not been satisfactorily explained by

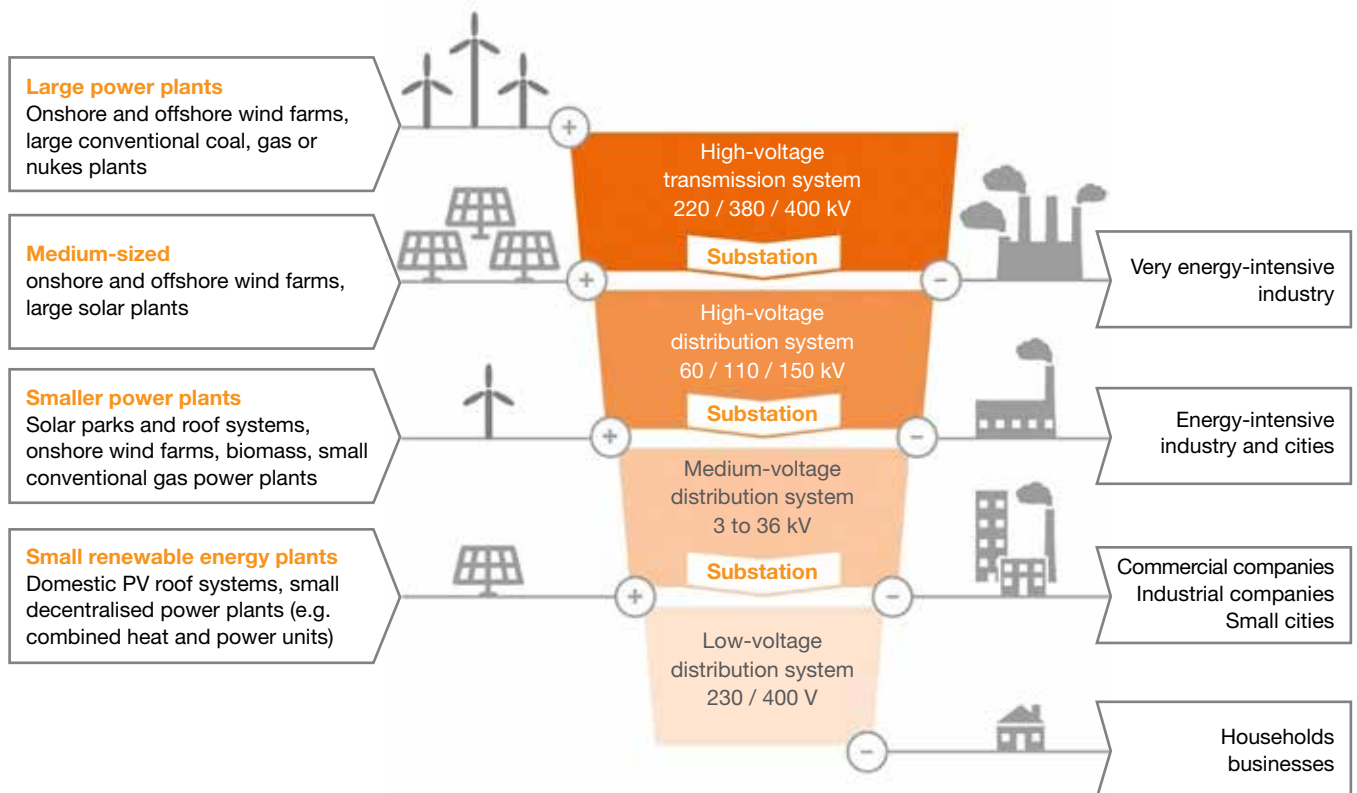

Figure 19. Power grids: Technology depends on the voltage level

Source: Germanwatch, based on 50Hertz transmission

the international research community. Second, on a more general level, people are uncomfortable with the invisibility of EMF, which they feel is not addressed satisfactorily either. Therefore, further research and transparent information about the impacts of EMF is needed. Power grid planners need to take health-related issues very seriously. They should provide detailed information on the potential impacts of electromagnetic fields and cooperate with experts from universities in explaining their potential impacts.

- **Decrease in property value:** In many cases, public objections to a grid extension project may remain despite efforts to reduce impacts, as some power lines will need to cross private property, particularly in densely populated areas. There are different types of compensatory measures which need to be considered or taken according to national law, including:
  - **Financial compensation for land, forest, or property owners:** Property owners are compensated according to national law when the approving authority obliges them to accept a pylon being built on their property or spanning a line over their property.
  - **Compensation for communities:** In some countries, for example in Germany, TSOs pay compensation for the construction of new transmission lines on municipal territory. Compensatory measures for communi-

ties can also include non-financial measures that reduce the negative impacts of other local projects.

- **Compensatory measures for environmental impacts:** If environmental impacts cannot be avoided, then compensation must be awarded according to European and national nature conservation legislation.

### Technology: Overhead line or underground cable?

Faced with the upgrade or construction of new power lines, many affected communities or civil action groups have been requesting that grid operators use underground cabling instead of overhead power lines. However, there are compelling economic and technical reasons to do otherwise.

In general, the voltage at which electricity is transmitted or distributed determines the technology applied. In various European countries, grid operators use underground cabling for a large part of the low- and medium-voltage network. For extra-high voltage lines in the transmission grid, this is very rarely the case. This is due to several technical and economic constraints for underground cable technology at higher voltage levels. At the extra-high voltage level (EHV), technical restrictions and risks, especially within the AC technology, as well as the substantially increased costs, explain why overhead technology is the world's most commonly used technology.



However, “partial undergrounding” has become prominent in some parts of Europe. Underground cables in AC technology at the extra-high voltage level are sometimes used for small sections of the transmission grid (mostly about 3-5 and up to 10 km in length) in densely populated areas. Several small-scale projects have been implemented, one of the largest being the Dutch Randstad 400kV AC cable, spanning over 10 km, laid near Rotterdam and operated by the transmission system operator TenneT. Other such projects are planned in Denmark, Belgium, and Germany.

Due to technical challenges and economic restrictions, underground cable technology will presumably not prove to be an easy solution for the upcoming transmission grid projects. But partial undergrounding may in some cases contribute to acceptable solutions for some projects. The use of underground cables should be based on the development of comprehensible criteria developed in a transparent procedure. This requires consultation with a broad range of stakeholders. The feasibility of different technology options needs to be addressed and communicated in public consultations. This includes an open and honest dialogue about the feasibility, restrictions, disadvantages, and advantages of different technology options.

## Nature conservation

Power grid extension projects, which form part of the energy transition, have impacts on the landscape and the natural environment. Therefore, environmental impact assessment plays an important role in the planning procedure. The EU Environmental Impact Assessment Directive and nature conservation directives determine common, high environmental standards that are applied in grid development. But there is considerable scope for advancing good practice in complying with these regulations and in other areas of nature protection and enhancement.<sup>9</sup>

## Early cooperation between grid operators and environmental groups

The BESTGRID project partners, TSOs and NGOs alike, have discovered that local stakeholders are highly interested in being involved in the corridor- and route-finding procedure. They rightly demand a transparent explanation of the criteria for choosing one or several route alternatives.

However, early stakeholder engagement per se does not of course mean that all concerns can be dispelled. Even the best participatory approach cannot provide a generally accepted solution, bearing in mind that a broad range of differing interests is affected by large transmission grid projects such as the Belgian Stevin project. Those who live near the power line may, understandably, reject the project as such and will not be

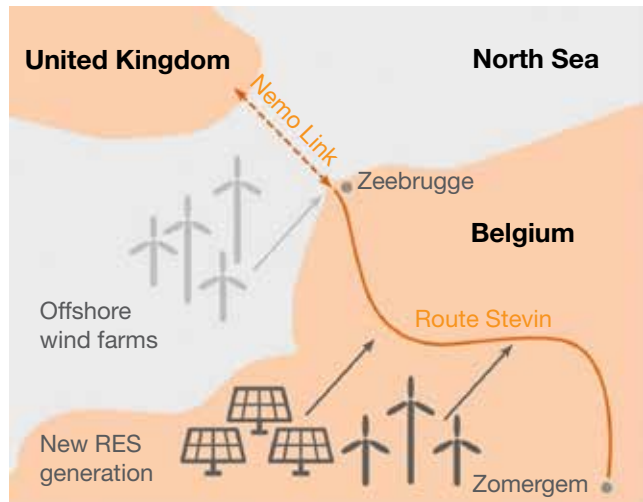

Figure 20. NemoLink interconnector between England and Belgium, and Stevin project, Belgium

Source: Germanwatch, based on Elia 2014

satisfied even by a procedure that follows good practice. But a transparent and participative approach may result in a better and more legitimate final decision reflecting the concerns, suggestions, and interests of a broader range of stakeholders.

European TSOs have tested and analyzed new ways of allowing early public participation within several BestGrid pilot projects (ie., the NemoLink interconnector and the Belgian StevinLink project).

Learning from these experiences, they are fully aware that this is the beginning of a long but important and fruitful process of establishing a regular public dialogue on the future power grid development in European countries. They see the dialogue as a joint learning process, not as a “push and accept” strategy. This process needs strong backing by national policymakers who must explain the importance of power grid infrastructure for the transition towards a low-carbon power system that can guarantee a safe, secure, and sustainable energy future.

## References

- 50Hertz Transmission (2014). The 50 Hertz electricity highways. How overhead lines work.
- Arnstein, S (1969). A Ladder of Citizen Participation. *JAI*, 35 (4) 216-224, or: [www.lithgow-schmidt.dk/sherry-arnstein/ladder-of-citizen-participation.html](http://www.lithgow-schmidt.dk/sherry-arnstein/ladder-of-citizen-participation.html)
- Balke, J (2014). Integration of Renewable Energy in Europe. KEMA Consulting. Report on behalf of the European Commission. [https://ec.europa.eu/energy/sites/ener/files/documents/201406\\_report\\_renewables\\_integration\\_europe.pdf](https://ec.europa.eu/energy/sites/ener/files/documents/201406_report_renewables_integration_europe.pdf)
- Bals C, El Alaoui A & Hänlein R (2015). Public Participation and Transparency in Power Grid Planning. Recommendations from the BEST-GRID Project. Handbook - Part 1. <https://germanwatch.org/en/download/11062.pdf>

<sup>9</sup> See Part 2 of the BestGrid handbook “Protecting Wildlife and Nature in Power Grid Planning” (2015, Birdlife Europe, 2016)

Bundesnetzagentur (2015). Mitreden beim Stromnetzausbau. [http://www.netzausbau.de/SharedDocs/Downloads/DE/2015/FAQ-Konsultation.pdf?\\_\\_blob=publicationFile](http://www.netzausbau.de/SharedDocs/Downloads/DE/2015/FAQ-Konsultation.pdf?__blob=publicationFile)

Elia (2014). Het Stevin-project, essentieel voor de energiebevoorrading van België. [http://www.elia.be/~media/files/Elia/Projects/stevin/Projectbrochure\\_Stevin.pdf](http://www.elia.be/~media/files/Elia/Projects/stevin/Projectbrochure_Stevin.pdf)

Rau, I. Schweizer-Ries, P & Hildebrand, J (2012). Participation Strategies: the Silver Bullet for Public Acceptance? In: Kabisch, S et al: Vulnerability, Risk and Complexity: Impacts of Global Change on Human Habitats, Leipzig, 177-192.

Rottmann, K (2012). Recommendations on Transparency and Public Participation in the Context of Electricity Transmission Lines. Position Paper. <https://germanwatch.org/en/download/8649.pdf>

Sander, A & Schneider T (2012). European Grid Report. Beyond Public Opposition. Lessons Learned Across Europe; Renewables Grid Initiative, Berlin. [http://renewables-grid.eu/uploads/media/RGI\\_European\\_Grid\\_Report\\_final\\_01.pdf](http://renewables-grid.eu/uploads/media/RGI_European_Grid_Report_final_01.pdf)

## 1.6. Safety culture in high risk industry and main principles

Lubomir Tomik,  
Consulting company CESys Ltd.

Safety culture plays an important role for all high-risk industries, including energy and transmissions systems operations. Improvement in human safety behavior is the most cost-effective solution to strengthen risk management. Human factors play a decisive role in failure management and

account for about 80% of all events. To increase network resilience and improve disaster risk management, a solid and practical safety culture is essential.

### What is Safety Culture?

Simply put, safety culture (SC) is that part of a culture which relates to safety. It is a subset of the following elements that relate to safety: shared mental content, norms, institutions, and characteristic of physical items, such as things that people make, have, use, or respond to, for example, forms, procedures, signs, equipment (Corcoran 2010).

One example is nuclear energy. The following differentiations and categories of safety culture are given by the International Nuclear Safety Advisory Group (INSAG): i) individual commitment to safety, which includes personal accountability, questioning attitude and effective safety communication; ii) management commitment to safety, which includes leadership safety values and actions; iii) decision-making and respectful work environment; and iv) management systems, which include continuous learning, problem identification and resolution, and the right environment for raising concerns and work processes.

According to INSAG, safety culture can be defined as following: "Safety culture is that assembly of characteristics and attitudes in organizations and individuals which establishes that, as an overriding priority, nuclear plant safety issues receive the attention warranted by their significance."

### James Reason – Five components of Safety Culture

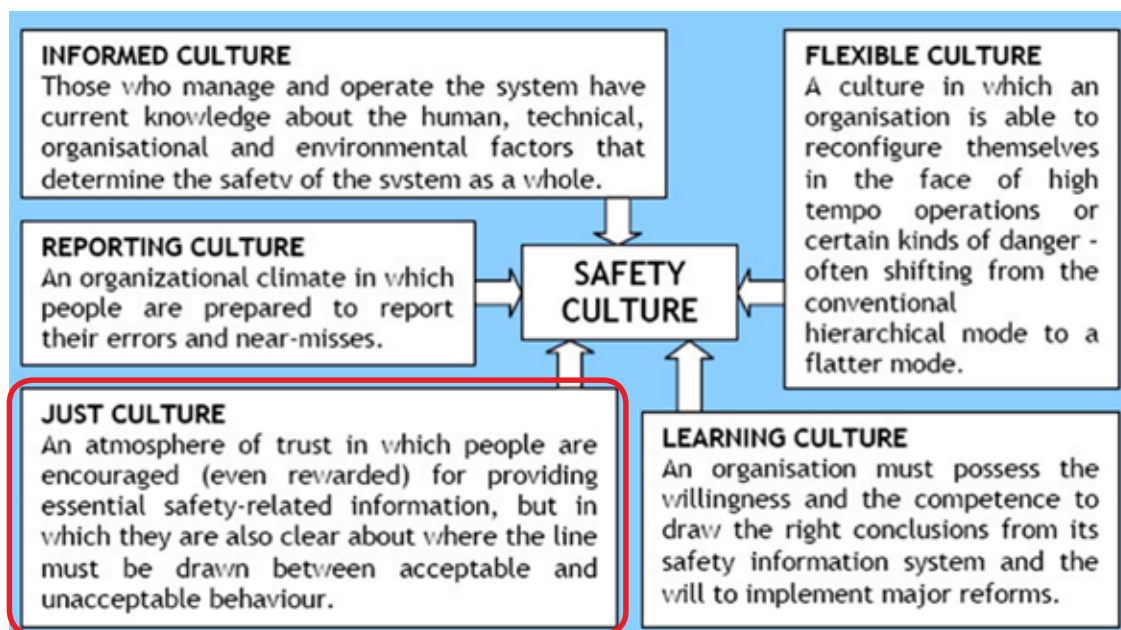

Figure 21. Safety culture

Source: Corcoran 2010

## Just Culture Process

**Tool No 2**

Figure 22. Just Culture Process

Source: Reason, 1998

The World Association of Nuclear Operators (WANO) defines the following approach to safety culture, based on eight principles: i) everyone is personally responsible for nuclear safety, ii) leaders demonstrate commitment to safety, iii) trust permeates the organization, iv) decision-making reflects safety first, v) nuclear technology is recognized as special and unique, vi) a questioning attitude is cultivated, vii) organizational learning is embraced, and viii) nuclear safety undergoes constant examination.

Another example is the aviation industry. For instance, according to the document published by UK CAA in 2002, there are the following recommendations to aviation maintenance organizations: general and introduction to human factors, safety culture and organizational factors, human errors, human performance and limitations, environment, procedures, information, tools and practices, communication, teamwork, professionalism and integrity, and an organization's human factors program.

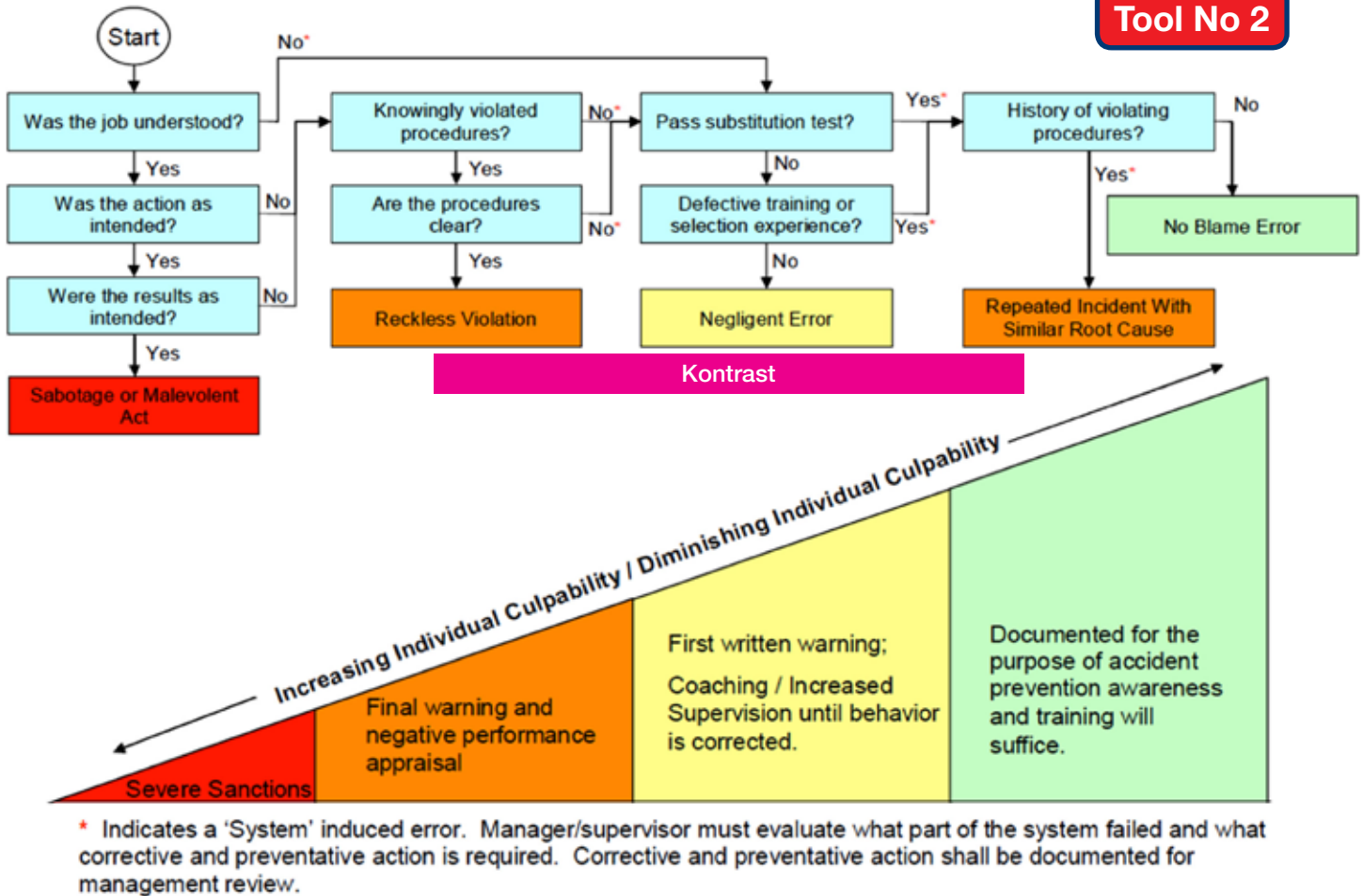
According to psychological theory, safety culture is very complicated as "most of the culture is below the surface. Above the surface we find the visible aspects of culture: artifacts, people's actions, and language use." (Schein, 1985). It

is impossible to underestimate any details. Preventing failure and critical thinking can prevent fatal outcomes.

One of the examples of implementation of safety culture is the project, being carried out by Slovenske elektrarne, the Slovenian part of the ENEL group. The approach is based on the following performance drives: equipment performance, organizational culture, processes, human performance, performance excellence. To achieve a common approach to safety, the project has the following deliverables: revised corporate policies, development of clear set of values and behavior that support safety, preparation of new tools and operational procedures, implementation and communication plan, specific training for workers and management, regular self-assessment and benchmarking on the application of the principles of safety culture.

Another example of the tools used is an employee award program. This reinforces exemplary behavior on the part of all employees through visible positive support and the presentation of awards to those who act as role models in terms of observing safety principles; it also motivates employees to actively report their concerns, weaknesses, and safety improvement issues. Another important aspect is to reinforce

# Safety Message of the Week

Week 16

Relates to SC principles: 1, 6, 7

1. Everyone is personally responsible for safety.
2. Leaders demonstrate commitment to safety.
3. Trust permeates the organization.
4. Decision making reflects safety first.
5. The nuclear technology is recognized as special and unique.
6. A questioning attitude is cultivated.
7. Organizational learning is embraced.
8. Safety undergoes constant examination.



## When lifting, slinging and handling loads safety is a priority

### Safe behaviour examples

- ✓ I only carry out lifting and slinging work with the required qualification.
- ✓ As a slinger I monitor the whole path of the load. I make sure it is not transported over people working below and I myself do not stand under the load.
- ✓ As a slinger I warn people about the load moving above them in a timely manner.
- ✓ When a load is lifted in a complex environment, an independent supervisor is called for.
- ✓ Before working with lifting equipment I review its functioning and make sure there are no unsecured objects that may fall.

Area : Occupational Health and Safety

### Risks and unacceptable behaviours

- ✗ Persons passing under the moving load do not avoid the load being transported.
- ✗ When transporting the load, the slinger does not move along with the load to warn the persons passing by.
- ✗ Managers are not trained about the basic rules of load lifting and slinging.
- ✗ Issues and near - misses related to slinging and lifting are not reported or investigated.



Author: Maintenance – B2000

Figure 23. Safety Message

Source: Slovenske Elektrarne

trust between management and employees using various financial and non-financial awards.

A further tool is the **Culpability tree implementation** in the Just Culture (Figure 22). According to this tool there are several forms of unsafe behavior: human error, which includes an unintentional act; an act carried out unwillingly by a person; negligent conduct, when a person did not pay enough attention; reckless conduct, when a person did not care about what happened; and intentional “willful” violations. We can transform such a culture to a process diagram (see Figure 23).

**Confidential reporting** is another tool. A confidential channel for the reporting of issues should be established at each plant to allow reporting of any kind of safety issue without disclosing the originator of the report. According to WANO, eight out of ten events regarding fuel damage in reactor core are caused by human failure; 75% of reported events at NPPs is caused by human error; 15-20% of production losses result from incorrect company decisions.

Implementation of the tools should be accompanied by a proper communication process such as weekly safety messages, the main goal of which could be to initiate a regular discussion between management and employees on safety issues. There needs to be reinforcement of a risk awareness environment and every employee should be involved in and responsible for improvements to the safety culture and finally achieve common understanding and implementation of values and behaviors supporting SC principles. Usually the content, topic, schedule and type of communication is prepared by the plant SC committee. Topics are identified to support expected behaviors, good practices, and lessons learned (Figure 23).

The tools introduced in this article are examples of tools for use only in high-risk industries. Safety culture, like culture generally, is difficult to measure. However, in several high risk industries, the evaluation of safety culture is a regular activity carried out a few times per year, and usually divided into two parts: anonymous self-evaluation by workers and evaluation by an external third party, usually a specialized

company, which uses sophisticated methods and tools to measure various criteria.

Today, the science of safety culture is well developed particularly in the aviation, nuclear, and space industries. Implementation of this knowledge with respect to electricity transmission networks will provide additional synergies for overall protection, reducing negative trends and operational risks, given that human error is the biggest contributor to industry disasters.

## References

Corcoran, W., (2010). Safety Culture — Back to the Basics, PhD Thesis, 2010

Reason, J., (1998). Achieving a safe culture: theory and practice. *Work and Stress*, 1998, vol.12, No.3, 3 293-306

Schein, Edgar H., *Organizational Culture and Leadership* (1985). University of Illinois at Urbana-Champaign's Academy for Entrepreneurial Leadership Historical Research Reference in Entrepreneurship. Available at SSRN: <http://ssrn.com/abstract=1496184>

## 1.7. Electricity grid resilience under climate change

**Martin König,**  
Department for Environmental Impact Assessments and Climate Change,  
Environment Agency, Austria

### Introduction

Electricity grid infrastructure is highly exposed to weather and climate as the sum of all weather conditions at a certain spot. The line-bound infrastructure of electricity transmission and distribution is also crucial, as damage at a single spot could lead to failures across the network. Several projects of the Austrian Environment Agency in recent years have shown how vulnerable these infrastructures are to climate impacts and how important it is to take action to increase their resilience.

While mitigating greenhouse gas emissions has been the focus of climate action for decades, *adaptation* policies are a new but vital approach to coping with the effects of changing climatic parameters. Indeed, different studies suggest that climate change has significant impacts on the energy sector and emphasize the need for adaptation in the sector (Rademaekers et al. 2011; Ebinger and Vergara 2011; Williamson et al. 2009). Climate change impacts, such as increased frequency



**Figure 24. Power line damages caused by wind throw.**

Source: FF Güssing, [www.feuerwehren.at](http://www.feuerwehren.at)

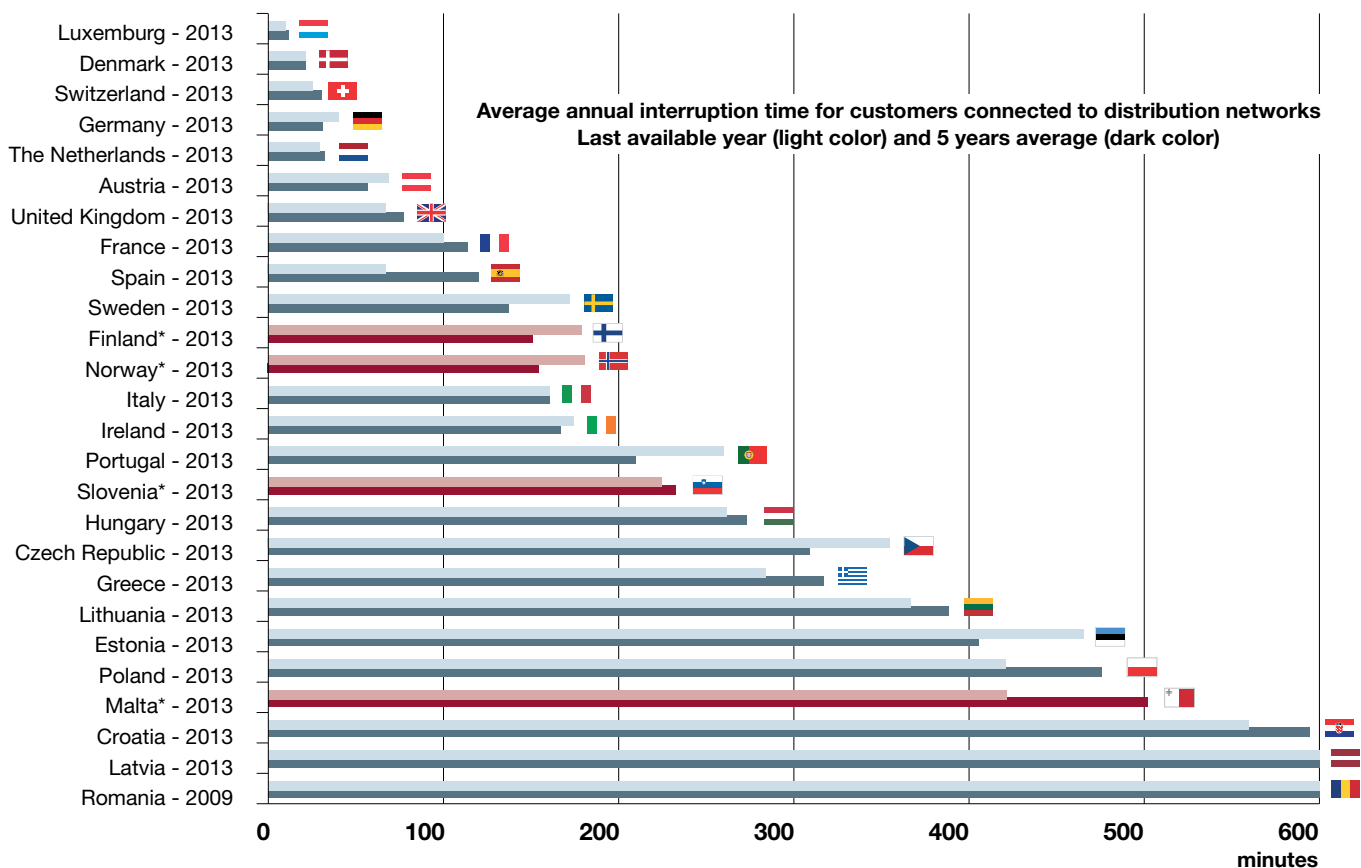

**Figure 25. Ice crusts damaging power lines in Carinthia, Austria, in winter 2014**

Source: KELAG

of extreme weather events or changing water and air temperatures, affect energy demand, supply, and transmission. Adaptation should therefore be considered at the planning and operating stages of energy systems at all territorial levels, from local to European. While adaptation is not necessarily a separate field of action, it is, suitable for mainstreaming into existing energy policies on, for example, the internal energy market, TEN-E/CEF, the energy road map, energy efficiency policies, and other strategies already set by important players in the field, like the European Union (cf. Strategic Energy Technology Plan and Smart Grid initiative). Furthermore, grid operators should factor (changing) climate parameters into their network security plans and maintenance.

A great number of greenhouse gas mitigation measures and policies have the potential to indirectly include and mainstream adaptation, that is, to maintain/enhance security of supply. This includes measures not only on the demand side of electricity consumption, but also those connected to the extension of renewable energy systems, such as diversification of energy supply to reduce energy imports from politically instable regions and decentralization of electricity



**Harmonized total SAIDI: Average annual interruption time for LV customers, all interruptions considered**

Light blue bar: Last available year (indicated next to the country name)    Dark blue bar: Average over the five last years (available years only)

**Non-harmonized average annual interruption time, all interruptions considered**

Interruptions which originate from incidents on LV networks not taken into account, or average annual interruption time taking into account MV customers and weighted by average consumption  
→ Likely underestimated compared to "harmonized total SAIDI", by about 5-20%

Latvia: 621 minutes in 2013,  
834 minutes in average over 5 years  
Romania: 1005 minutes in 2009

Light red bar: Last available year (indicated next to the country name)    Dark red bar: Average over the five last years (available years only)

**Figure 26. Per capita average minutes without electricity (based on the SAIDI index, i.e., average outage time per capita). Note that exceptional weather events and planned (technical) interruptions as well as interruption below 3 minutes are not considered for the SAIDI index.**

Source: CEER (2015).

production. It is important to stress that mitigation efforts sometimes go hand in hand with adaptation in terms of raising resilience. For example, cutting summer-time demand peaks reduces the risk of failure in the electricity grid due to overloads and so-called flashovers (high-voltage discharges caused by lightning). This concept is further elaborated in the background report for the European adaptation strategy (McCallum et al. 2013). In general, climate change and changing patterns of extreme weather events and periods are hitting a European infrastructure that was constructed 50-60 years ago and an energy market that is more interconnected than ever before with highly loaded transnational grids.

**Vulnerability of grid infrastructure**

Electricity grid infrastructure is directly exposed to extreme weather conditions. Overhead lines as well as substations and transformers are potentially threatened by storms (wind throws, see Figure 24), icing (see Figure 25), wet snow deposits, lightning, floods, and mass movements such as avalanches, landslides, and rock falls.

Heatwaves are also a stress factor for the transmission and distribution grid. In transmission terms, they constitute an indirect stress factor because the use of air conditioning creates a higher demand/load, resulting in a higher risk of flashovers. In distribution terms, heatwaves are a direct stress factor due to heating of cables – overhead and, even more so, underground (urban) cables.

There is, however, no clear evidence of a correlation between blackouts. This is indicated by the performance of the Customer Average Interruption Duration Index (CAIDI; for 16 European countries in 2004/2005) (Figure 26) on the one hand and rising temperatures, droughts, or increased frequency of extreme events on the other. We are thus unable, as yet, to fully assess the impact of climate change on electricity supply security. Current documentation by energy regulators, however, suggests an already high share of weather-related outages and even blackouts.

Some examples of major weather-related blackouts:

- Blackout in September 2003 in Italy, caused by a flashover from trees to the heavily overloaded Lukmanier and San Bernardino highest voltage transmission lines, storm events, and heavy demand for cooling purposes.<sup>10</sup>
- Blackouts in Sweden in September 2003 and January 2005, when a series of rainstorms caused blackouts for 3.5 million and 400,000 people, respectively.
- Blackout in Germany in November 2005 where wet snow deposits caused a long-lasting blackout for around 250,000 people in the Münster region.<sup>11</sup>

These, as well as numerous small-scale blackouts, show how vulnerable the electricity grid is to weather and climate extremes. The large-scale event in 2003 in Italy shows how accelerated electricity demand due to a heatwave and severe weather can collude to produce highly adverse effects. In fact, the event in question constitutes a clear warning sign for hot summer threats and vulnerabilities across Europe.

Special attention should be given to the fact that grid lines, when pushed to the limits of their capacities, are more vulnerable to flashovers from trees. There is thus a correlation between reduced grid transmission capacity due to weather and climate extremes<sup>12</sup> and the occurrence of blackouts.<sup>13</sup>

In principle, all European citizens can expect to be affected by blackout threats, particularly because of the cascading effects that come into play when blackouts occur. In fact, country comparisons of the average per capita minutes without electricity per year, as depicted in Figure 26, show different vulnerability patterns emerging across Europe.

## Disparities at the regional level

Differing regional vulnerabilities result from discrepancies between urban, rural, and higher-scale high-voltage trans-

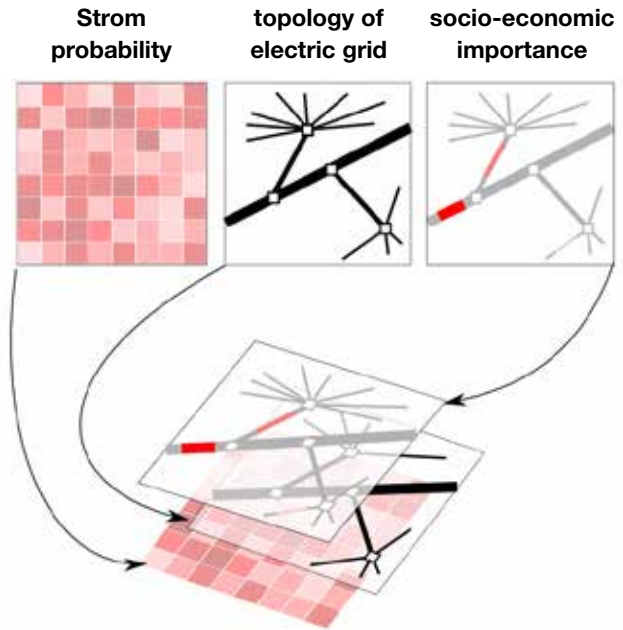

Figure 27. Damage parameters (for example, storm), grid topology, and number/type of households and companies, determining the vulnerability of grid infrastructure and the impacts of failure.

Source. Offenthaler, 2015

mission and distribution in (remote) regions. According to qualitative data gathered, most cities across Europe use underground cabling to some extent as distribution infrastructure for electricity. That is why, for example, *Wien Energie*<sup>14</sup> (Vienna's main energy supplier and Distribution System Operator [DSO]) with its 83% share of underground cabling can be regarded as climate-resilient, at least in terms of the distribution infrastructure. Urban heatwaves are also problematic – especially for underground cables beneath dark surfaces with low albedo such as pavements (which heat up fast due to their low reflective properties). Substations and transformers, however, are still exposed to extreme events and can fail; so, too, are interconnections to and from the overhead grid.

The differences in vulnerability between overhead and underground cables come down to the fact that underground cables are per se protected from direct meteorological impacts like wet snow deposits, icing, and storms. Nevertheless, in urban areas heatwaves remain a risk factor, as do mass movements (especially landslides) in mountainous terrain.

DSOs play an important role in the design of resilient grid structures, as they are the most vulnerable towards extreme weather events such as wind, snow, and ice load; this is because their infrastructure – especially medium- and low-voltage overhead infrastructure – is particularly vulnerable

10 Cf. <http://news.bbc.co.uk/2/hi/3146136.stm> and SFOE (2003) for more details

11 Cf. [http://de.wikipedia.org/wiki/Liste\\_historischer\\_Stromausf%C3%A4lle](http://de.wikipedia.org/wiki/Liste_historischer_Stromausf%C3%A4lle) and [http://news.xinhuanet.com/english2010/world/2010-03/15/c\\_13211267.htm](http://news.xinhuanet.com/english2010/world/2010-03/15/c_13211267.htm)

12 Cf. NatCat Service data from MunichRe at for example: [http://www.munichre.com/app\\_pages/www/@res/pdf/NatCatService/great\\_natural\\_catastrophes/NatCatSERVICE\\_Great\\_1950\\_2011\\_losses\\_weather\\_de.pdf](http://www.munichre.com/app_pages/www/@res/pdf/NatCatService/great_natural_catastrophes/NatCatSERVICE_Great_1950_2011_losses_weather_de.pdf)

13 Cf. CEER (2008) at [http://www.energy-regulators.eu/portal/page/portal/EER\\_HOME/EER\\_PUBLICATIONS/CEER\\_PAPERS/Electricity/2008/C08-EQS-24-04\\_4th%20Benchmarking%20Report%20EQS\\_10-Dec-2008\\_re.pdf](http://www.energy-regulators.eu/portal/page/portal/EER_HOME/EER_PUBLICATIONS/CEER_PAPERS/Electricity/2008/C08-EQS-24-04_4th%20Benchmarking%20Report%20EQS_10-Dec-2008_re.pdf)

14 [www.wienenergie.at](http://www.wienenergie.at)

Table 8. Climate impacts and risks for electricity transmission and distribution

Type	Natural hazard	Risk	Time frame of expected impact	Main affected area
Transmission and distribution networks directly	Extremely high temperatures	Decreased network capacity	Medium negative (2025) to extreme negative (2080)	EU-wide
	Snow, icing storms	Increased chances of damages to energy networks and blackouts	Medium negative to low positive (2050)	NW-EU
	Heavy precipitations	Mass movements (landslides, mud and debris flows) causing damages	Time frame, magnitudes, and frequencies uncertain	Especially mountainous regions
Energy demand indirectly affecting electricity transmission and distribution	Higher temperatures	High AC demand in summer; high cooling demand by food industry	Short-term medium to long-term strong negative (i.e., rise in electricity demand in summer season)	EU-wide
	Droughts	Low heating demand in winter	Positive (for both; cf. studies by Dolinar et al. 2010 for SI, Mirasgedis et al. 2007 for GR and Christenson et al. 2006 for CH)	Southern and eastern Europe
	Droughts	High energy demand from pumping for irrigation	Low negative	

Source. König in Altwater et al. (2011)

(see Martikainen et al. 2007) on Finland. However, the big energy producers own a good share of the distribution network – either directly or through subsidiaries.

Vulnerability is a function of exposure (of the grid infrastructure to weather influences), its sensitivity (i.e., its physical strength), and the capacity (of grid operators) to adapt to or cope with meteorological/climatological challenges. Thus, regional impacts are affected by the number of components and the physical strength of the grid infrastructure (including power poles, power line configuration, transformers, substations, etc.); the meteorological hazard potential (e.g., susceptibility to storms, mass movements, icing, wet snow deposits, etc.); and the number of households and companies that depend on the infrastructure for their electricity supply. The respective layers are shown in Figure 27.

### Example of Austria: National climate change strategies as a response to climate change

Electricity and grid resilience have been incorporated into several national climate change adaptation strategies. In the Austrian adaptation strategy, some of the measures in the energy/electricity sector focus on the grid. These are:

- Optimizing the grid infrastructure to avoid bottlenecks and overcapacities
- Development and promotion of decentralized energy production and supply
- Adapted system planning for the transmission and distribution grid
- Reduction of energy demand especially peak demands (BMLFUW 2012)



Measures to increase the resilience of the transmission/distribution grid infrastructure can be classified into 1. technical measures; 2. measures on standards and regulations; 3. capacity building; 4. communications and awareness-raising; 5. guidelines, and 6. EU financing schemes (McCallum et al. 2013) as follows:

## 1. Technical measures

### 1 Making the grid climate-proof (*measure 13-15*)

**Transmission:** Installing additional network capacities with a special focus on volatile base load countries and regions with high potential and future dependence on non-base load capable renewable energy sources. This measure refers to smart grid activities that have already been implemented (e.g., EDSO-SG) but do not, as yet, take into account the threats of climate change to the security of supply through the stepwise implementation of renewable energy goals.

**Transmission:** Installing additional network capacities with particular respect to countries and regions with storage potential. For instance, in Norway there only pumped storage units currently exist (cf. ENTSOE 2010). However, water pumping storage capacities have the highest efficiency.

**Distribution:** Making stronger use of the electric railway network to further decentralize the distribution and transmission network (*measure 12*). This measure would allow for cost-efficient support of additional urgently needed distribution capacities while using small-scale facilities to decentralize energy supply.

2 **Transmission:** Detect vulnerability hotspots (Williamson et al. 2009), for example, in the overhead transmission networks (*measures 16 and 18*) towards monitoring of mass movements, storms, floods, and overheating (*measure 10*)

3 **Transmission:** Install underground cables at vulnerability hotspots, which are expensive, according to ZEW, costs may be over ten times the costs of ordinary overhead transmission; the conductivity of underground cables is also limited due to fast warming and the additional cooling facilities needed.

4 **Transmission:** Expand aisles through forests to the degree necessary, which is controversial, but in some explicitly storm-exposed regions possibly unavoidable.

5 **Transmission/Distribution:** Depending on the scope of the measure, slope stability measures such as protective forests or technical measures are put in place.

6 **Transmission/Distribution:** Set up an early warning system (Williamson et al. 2009; Ebinger and Vergara 2011) for energy shortcuts.

High demand, for example, during heatwaves or cold spells leads to overheating of the network due to overuse. Extreme events are events, such as storms, icing, hail, or periods of droughts, combined with low hydropower and wind power, and heatwaves leading to overheating of the transmission of cables due to high temperatures (*measure 16*).

### Storage:

7 Install new storage facilities, such as pumped storage units, especially in regions with volatile base load (Ibrahim et al. 2008).

8 Explore potential of other storage methods, for example, hydrogen (H<sub>2</sub>) or methane (CH<sub>4</sub>) that can be built up in parallel with expanding the renewable energy share (Ibrahim et al. 2008, URS 2010).

9 Mid-term: Make use of and maintain existing gas distribution network for CH<sub>4</sub> transmission and storage, once the SABATIER process (“solar fuel,” or other biochemical methods) reach industrial application/marketability. (Currently, research is progressing fast on new methods for electrolysis and methanizing H<sub>2</sub> to CH<sub>4</sub>).

## 2. Standards and regulations

### Transmission:

10 Higher standards for overhead transmission cables with respect to increasing demands by climate change, such as temperature increase, and also energy demands, such as overheating (*measure 2.d*)

11 Empower ACER (Agency for the Cooperation of European Regulators) to unbundle the distribution and transmission network and promote competition among transmission system operators leading to enhanced investments in energy distribution and transmission networks. Most of these measures have to be financed by power suppliers/TSOs and should not be subject to public spending, only co-funding, as put forward in *measures 21-23*.

12 Foster standards in power transmission to further enable electrified railway networks to be used for decentralized distribution (*measure 1.c*)

## 3. Capacity building (*measures 1-6*)

13 **Transmission:** Engage in strong cooperation with the European Transmission Operators via ENTSO-E (mandated by internal energy market directive 2009/72/EC) to climate-proof the transmission network

14 **Transmission:** Enhance cooperation of ENTSO-E with small electricity producers to make the transmission network more resilient to natural hazards by better connecting decentralized energy supply facilities to the network

15 **Transmission/Distribution:** Promote cooperation among the European Electricity Grid Initiative (EEGI), the EDSO-SG (European DSO Association for smart grids), the grids R&D Roadmap 2010-2018, and ENT-SO-E's R&D activities towards European smart grid solutions that are not only suitable to optimize supply and demand issues but also to allow for emergency switches ("detours for transmission") of the network in the event of local/regional disruptions caused by meteorologically extreme events

#### 4. Communication/awareness raising

- 16 **Transmission/Distribution:** Provide information such as impact/vulnerability maps and good practice examples (Ebinger and Vergara 2011) and easy access to information to ENTSO, EDSO and all energy producers (e.g., communicate results from research projects such as AEOLUS to the wind power producers) (*measure 2*)
- 17 **Transmission/Distribution:** Take care for adaptation to be taken into account in further integration (Ebinger and Vergara 2011) of the national networks into a pan-European one (i.e., mainstream adaptation into further proceedings of ENTSO, EDSO, ACER, EEGI, and the execution of the SET plan.

#### 5. Guidelines

- 18 **Transmission/Distribution:** Develop check list and guidance for TSOs and DSOs to assess vulnerability and possible adaptation options (*measure 2*)
- 19 **Transmission/Distribution:** Develop guidelines for setting up pan-European early warning systems for energy shortcuts (*measure 6*)

#### 6. EU financing scheme

- 20 Increase funding within EU RTD funding schemes, most importantly for the following:
- **Storage:** Electricity storage systems and methods
  - **Transmission:** New material for transmission cables
  - **Transmission/Distribution:** Smart grids managing new demand patterns, system operations after disruptions and larger share of renewable energy
- 21 **Transmission:** Use market-based instruments such as tax reduction schemes to create incentives for TSOs to invest in further climate-proofed networking capacities. This would be a classic no-regret measure, since these investments have to be made anyway.
- 22 **Transmission/Distribution:** Use the European Commission-European Investment Bank (EIB) initiative "EU Sustainable Energy Financing Initiative" and the Marguerite equity fund (led by EIB) to mainstream adaptation into funded projects.

23 **Transmission:** Utilize EU Cohesion Funds to support large-scale energy adaptation projects

#### Conclusion

Increasing the resilience of the electricity grid infrastructure – and especially the distribution grid – is a core task for infrastructure providers. Special attention should be given to the privatized networks and the need to increase investment in electricity transmission infrastructure to make it more resilient to climate change impacts.

These investments are necessary as meteorologically triggered outages and blackouts are already significant and their frequency will increase in the future. The economic costs of service interruptions are extremely high.

#### References

- BMLFUW (2012): The Austrian Strategy for Adaptation to Climate Change. Vienna. [https://www.bmlfuw.gv.at/umwelt/klimaschutz/klimapolitik\\_national/anpassungsstrategie/strategie-kontext.html](https://www.bmlfuw.gv.at/umwelt/klimaschutz/klimapolitik_national/anpassungsstrategie/strategie-kontext.html)
- CEER (2015): CEER benchmarking report 5.2 on the Continuity of Electricity Supply. Data update. Brussels.
- McCallum S., Dworak T., Prutsch A., Kent N., Mysiak J., Bosello F., Klostermann J., Dlugolecki A., Williams E., König M., Leitner M., Miller K., Harley M., Smithers R., Berglund M., Glas N.,
- Romanovska L., van de Sandt K., Bachschmidt R., Völler S., Horrocks L. (2013): Support to the development of the EU Strategy for Adaptation to Climate Change: Background report to the Impact Assessment, Part I – Problem definition, policy context and assessment of policy options. Environment Agency Austria, Vienna. [http://ec.europa.eu/clima/policies/adaptation/what/docs/background\\_report\\_part1\\_en.pdf](http://ec.europa.eu/clima/policies/adaptation/what/docs/background_report_part1_en.pdf)
- Ebinger, J. & Vergara, W. (2011): Climate Impacts on Energy Systems. Key issues for energy sector adaptation. World Bank study. Washington. ([http://www.esmap.org/esmap/sites/esmap.org/files/E-Book\\_Climate%20Impacts%20on%20Energy%20Systems..pdf](http://www.esmap.org/esmap/sites/esmap.org/files/E-Book_Climate%20Impacts%20on%20Energy%20Systems..pdf))
- ENTSO-E (2010): Pilot Ten Year Network Development Plan. <https://www.entsoe.eu/system-development/tyndp-2010/>
- Ibrahim, H.; Ilinca, A. & Perron, J. (2008). Energy storage systems—characteristics and comparisons. Renewable and Sustainable Energy Reviews 12: 1221–1250.
- Martikainen, A., Pykälä, M.L., Farin J. (2007): Recognizing climate change in electricity network design and construction. VTT Research Notes 2419. <http://www.vtt.fi/inf/pdf/tiedotteet/2007/T2419.pdf>
- Rademaekers, K. et al. (2011): Investment needs for future adaptation measures in EU nuclear power plants and other electricity generation technologies due to effects of climate change. Final report. Published by European Commission. Brussels. ([http://ec.europa.eu/energy/nuclear/studies/doc/2011\\_03\\_eur24769-en.pdf](http://ec.europa.eu/energy/nuclear/studies/doc/2011_03_eur24769-en.pdf))
- URS (2010) Adapting Energy, Transport and Water Infrastructure to the long-term impacts of climate change. Ref. No RMP/5456. (<http://archive.defra.gov.uk/environment/climate/documents/infrastructure-full-report.pdf>)
- Williamson, L.E.; Connor, H. & Moezzi, M. (2009): Climate-proofing Energy Systems. ([www.helio-international.org](http://www.helio-international.org)).
- Williamson, L.E.; Connor, H. & Moezzi, M. (2009): Climate-proofing Energy Systems. ([www.helio-international.org](http://www.helio-international.org)).





## Chapter 2

# Case studies

Chapter 2 includes different case studies of electricity blackouts and power outages in Europe, in countries like Italy, Switzerland, Sweden, Norway, Germany, France, Serbia, Bosnia and Herzegovina, Croatia, Slovenia as well as an example from China. The contributions in this chapter are provided by the International Institute for Applied Systems Analysis (IIASA), ETH Zurich, Electro Lubliana, Slovenia, Energy Community Secretariat, Réseau de Transport d'Electricité (RTE), France and Human and Environment Linkage Program, an NGO from the US and China.

### 2.1. Case studies of three blackouts: 2003 in Italy and Switzerland as well as in Sweden and Denmark, and of 2006 in Germany

**Nadejda Komendantova**

International Institute for Applied Systems Analysis and ETH Zurich

#### Introduction

The recent power outages in several countries of Europe showed vulnerability of electricity transmission grids to multiple hazards, when interactions between different risks resulted in interruptions of electricity transmission. This contribution reviews three historical cases of blackouts in Europe, such as the blackout in the year 2003, which affected Italy and Switzerland, the blackout in Sweden and Denmark, which happened during the same year, and the blackout which happened in the year 2006 in Germany. The review of these case studies illustrates the variety of factors, which currently affect vulnerability of electricity transmis-

sion networks in Europe. It also shows the need of a multi-risk approach to build resilience of electricity transmission infrastructure and to address systemic risks, which affect electricity transmission infrastructure.

#### Background

In the year 2011 the European Commission published the roadmap towards the reduction of green house gas emissions in electricity generation by at least 80% by 2050, mainly through scaling up of renewable energy generation (COM, 2011). The 2030 EU policy framework on climate change and energy foresees an increase of the share of renewable energy by at least 27% (COM, 2014). Considering that the most of energy generated by renewable sources is consumed and transmitted as electricity, the 2030 target also increases the importance of electricity transmission networks as a major critical energy infrastructure. Also the European Union Energy 2020 Strategy identifies development of grids as a key factor for further deployment of renewable energies.

However, achieving the renewable energy targets, such as decarbonisation of electricity generation sector by 2050, will require substantial changes in quality and quantity of the grid infrastructure, including an increase in the number of international interconnectors, construction of long-distance transmission grids, a denser network of grids to connected distributed generation facilities and smart grid technologies to manage different energy supply options. The achievement of the 2030 target also requires providing security of electricity transmission.

Already in 2008 the European Council was highlighting the growing need to protect critical infrastructure, including electricity transmission grids, against multiple hazards (Directive 2008/114/EC). Currently protection of the grids, including blackouts prevention and minimization of their impacts, is in the responsibility of national states and the owners or operators of infrastructure, as a primary respon-

sibility to secure electricity supply (Directive 2008/114/EC). In the year 2009, the European Commission settled the overall framework for disaster prevention and minimization of the disasters impacts and advocated for the development of national policies based on the disaster management cycle, including such phases as prevention, preparedness, response and recovery. The European Commission also underlines the usefulness of a multi-hazard approach to prevent disasters (COM, 2010). The UN process also speaks about the need to strengthen multi-risk assessment “research methods and tools for multi-risk assessments should be developed and strengthened” (UNISDR, 2005) to address the vulnerability of the European Union infrastructure to multiple natural hazards such as earthquakes, floods, droughts, storms, heat waves, icing, fires and others, which not only damage infrastructure and its elements but also reduce capacities of electricity transmission (UNISDR, 2013).

### Methodology: three case studies

The blackout of the year 2003, which started in Switzerland and then also affected Italy, left 56 million of people without electricity. The blackout was caused by cascading effects of several failures. For instance, the overload of the 380 kV line between Mettlen and Lavorgo led to the raise of core temperature of the grid, which affected nearby trees and resulted in a flashover. The further failure of the Mettlen-Lavorgo line resulted in an increasing loading of the 380 kV Sils-Sosa line. The domino effect from the Swiss line put the entire Italian line out of synchronization with the Union for the Coordination of Transmission Electricity (UCTE), and led to the power outage in Italy lasting up to 16 hours.

Another blackout, which took place during the same year, affected 1.6 million people in Sweden and 2.4 million people in Denmark. It also resulted that 4.700 MW of load was lost in Sweden and 1.850 MW in Denmark. This was the most severe disturbance in the Nordic power system for the last 20 years. The blackout was caused by coincidence of several risks, which increased burden on the electricity transmission system. Prior to blackout, two 400 kV lines were taken out for service for maintenance works as well as the High Voltage District Current link between Poland and Germany. The failure disconnection of two busbars resulted that two nuclear units with total output of 1.750 MW were tripped, the grid lost its transmission capacity along the west coast, increasing heavy load of the grid in the remaining south-east and south-central parts. At the same time the demand in the area recovered and this lowered further the voltage of 400 kV, which ended in a voltage collapse in a section of the south-west grid close to Stockholm. Following this, the southern part of the grid between Sweden and eastern Denmark remained interconnected but was affected by massive inadequacy of generation. The remaining generators in Denmark were not able to increase capacity to satisfy the demand and within seconds

the frequency and voltage of the grid dropped and the entire subsystem collapsed. The major reason for this blackout was that a severe grid fault, such as failure of double busbar, which shutted down two major nuclear units and reduced transmission capacity, occurred only couple of minutes after the ordinary fault, such as the loss of a 1.250 MW generation unit. The probability of such coincidence is very low, but it shows the requirements of grid security standards, going beyond n-1 level (Larsson and Ek, 2003).

The blackout of 2006 in Germany lasted for up to two hours. This was a major blackout, which affected more than 15 million people. The blackout had cascading effects on people in Poland, Benelux countries, France, Portugal, Spain, Greece, Balkans and even Morocco.

The German TSO E.ON Netz had to switch off a high voltage line to let a ship pass underneath. Simultaneously there was a high amount of wind electricity, which fed into the grid 10,000 MW from wind turbines to Western and Southern Europe grids. Insufficient communication about this switch-off led to instabilities of the frequency in the grid and to overloading of lines. Devices had to switch customers off the grid in the affected countries. This was necessary to cope with the lack of power in the Western zone automatic. The investigation, carried by the Union for the Coordination of Transmission of Electricity (UCTE), identified three factors, which affected vulnerability of the grid. The first one was the absence of security tools by transmission system operator, which did not allow verification that the system was operating at security limits. The second was the absence of communication between European transmission system operators, who did not receive information about actions of the German transmission system operator. The third one was the lack of investment into reliability and operation of the grid (UCTE, 2006).

### Results: factors influencing vulnerability of electricity transmission grids

The three above mentioned case studies allowed identification of the following factors influencing vulnerability of electricity transmission networks: new requirements for electricity infrastructure in Europe, current state of electricity infrastructure, barriers for upgrading of infrastructure and enhancing its capacity, existing interdependencies between different electricity transmission systems and existing and emerging multiple risks.

Worldwide renewable power capacity grew by 85% over the past 10 years and reached 1.700 GW in 2013, making over 30% of all installed capacity (IRENA, 2014). The currently existing in Europe electricity transmission system was designed half a century ago to integrate electricity generated close to major energy consumption centers and mainly from the large-scale fossil fuel capacities. Today requirements for

the grid are changing and include the need to integrate growing volumes of renewable energy, which is located in different geographic areas and also often in the areas with low population density and low level of consumption. Renewable energy generation creates new challenges for electricity transmission grids, such as the difference in peak loads for demand and supply, need for adequate infrastructure to integrate varying outputs of renewable energy sources, fluctuations in demand and generation side changes. The so-called power ramps, which result from intermittent character of renewable energy generation, can seriously affect electricity grids. The grid stability is also affected in the areas of interconnectors, which were constructed to ensure stability of the grid and the back-up to adjust transmission systems. Deployment of renewable energy sources far away from the consumption centers requires that grids will be also able to gather and transmit electricity from different sources. If existing and future flexible and back-up units cannot be located close to renewable energy generation and use the same transmission grid, the need for more lines and smarter grid management will increase (Eurelectric, 2011).

Another challenge is the current shape of electricity transmission grids, which are aging. The majority of the grids is 30-40 years old, several thousands kilometers of grids need to be upgraded or replaced. In many countries grids are already at the border of their capacities and it is questionable if this capacity will allow integration of the growing volumes of electricity generated by renewable energy sources (EWEA, 2010). Also cross-border interconnectors need upgrading (Battaglini et al., 2012).

The European high voltage transmission grid is composed of high and low voltage lines. Vulnerability of electricity grids in Europe is also affected by interdependencies between different systems and potentials for cascading effects (Poljanšek et al., 2012). Integration of renewable energies and resilience of electricity grids to multiple risks require substantial upgrading of existing grids as well as deployment of new grids. Around 42,000 km of transmission lines need to be upgraded or constructed to secure market integration, security of supply and to accommodate the renewable expansion planned for 2020 (ENTSO-E, 2010). There are different challenges for further deployment of electricity transmission grids, which go beyond the technical and financial barriers. Rather the lack of regulations and acceptance for further deployment of electricity transmission infrastructure are major bottlenecks. The inability to properly address public and social acceptance issues may cause enormous delays and even cancellation of the projects. For instance, in some countries no single line at voltages higher than 200kV was constructed during the last 10 years (ENTSO, 2006). Only in Germany 3.600 km of new 380kV lines have to be constructed until 2020, however, since 2005 only 80 km of new grids were constructed (DENA, 2012).

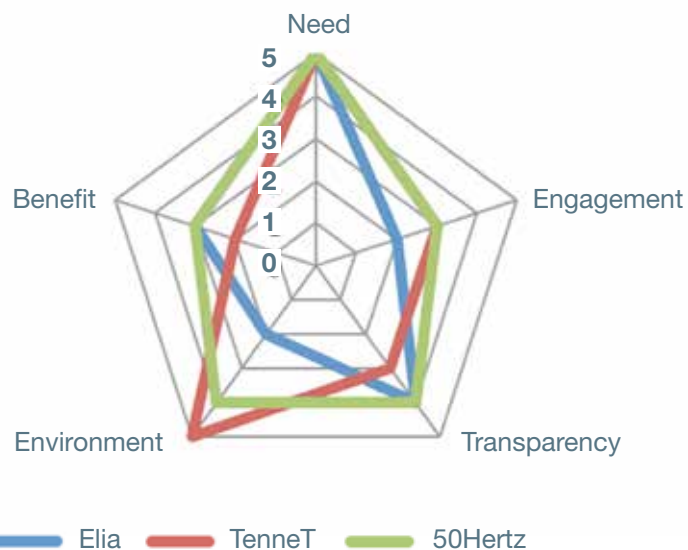

**Figure 28: Concerns according to five guiding principles**

Source: Komendantova et al., 2015

Public acceptance is currently one of the major bottlenecks for upgrading of the grids. The EU supported BESTGRID project identified that inhabitants of communities, which will be affected by planned electricity transmission infrastructure question on the first hand the need of such projects. The review of pilot projects realized Elia, TenneT and 50 Hertz in Germany and Belgium showed that concerns about the need of such projects were the most frequently expressed concerns (figure 28).

A number of events, which we designed in frames of the BESTGRID project, showed the successfulness of the actions to provide more information about the need of the electricity transmission projects, such as round table discussions of information markets.

Stakeholders especially appreciated actions on providing more information in the form of detailed maps about alternative corridors, possibilities for direct discussion with the representatives of the companies realising the projects and involvement of local NGOs into organisation of public information events.

## Discussion:

As recent blackouts in Italy, Switzerland, Sweden, Denmark and Germany showed, the electricity transmission infrastructure is a very complex system, which can become a subject to cascading effects of different risks and to trans-boundary risks, affecting several countries. Reducing vulnerability of electricity transmission grids requires consideration of multiple risks as well as interdependencies between these risks.



Figure 29: Public information events in frames of BESTGRID project

Source: RGI, 2015

This already extremely complex system is currently undergoing changes, which might increase its complexity and vulnerability. For instance, electricity transmission architecture is changing and is facing challenges of intermittent renewable electricity, decentralized electricity generation, two-ways electricity flows, from producer to consumer but also from consumers back to the grid. Besides of this, grid becomes a subject to multiple risks, which includes already existing and known risks but also includes emerging and new risks.

All these factors require a multi-risk and a systemic approach in risk assessment, which will consider conjoint and cascading effects of multiple risks as well as a multi-risk governance approach in risk mitigation and management.

## References:

- Battaglini A, Komendantova N, Brtnik P, Patt A (2012). Perception of barriers for expansion of electricity grids in the European Union. *Energy Policy*, 47:254-259.
- COM (2014). Communication from the Commission to the European Parliament, the Council, the European Economic and Social Committee and the Committee of the Regions. A policy framework for climate change and energy in the period from 2020 to 2030. Brussels, 2014.
- COM (2011). Risk assessment and mapping guidelines for disaster management. European Commission staff working paper, European Union, Brussels, 2011.
- COM (2010). A Community approach on the prevention of natural and man-made disasters. 2010. Risk Assessment and Mapping Guideline for Disaster Management. European Commission Staff Working Paper 1626, Brussels, 2010.
- DENA (2012). Planning of the Grid Integration of Wind Energy in Germany Onshore and Offshore up to the Year 2020 (dena Grid study). Deutsche Energie Agentur, Berlin, 2012.
- ENTSO-E (2010). Ten-year network development plan 2010-2020. European Network of Transmission System Operators for Electricity (ENTSO-E), Brussels, 2010.
- ETSO (2006). Overview of the administrative procedures for constructing 110 kV to 400 kV overhead lines. European Transmission System Operators (ETSO), 2006.
- EURELECTRIC (2011). Power statistics and trends. Synopsis, December 2011.
- EWEA (2010). Large Scale integration of wind energy in the European power supply: analysis, issues and recommendations. European Wind Energy Association (EWEA) Brussels, 2010.
- ETSO (2006). Overview of the administrative procedures for constructing 110 kV to 400 kV overhead lines. European Transmission System Operators (ETSO), 2006.
- IRENA (2015). Renewable Power Generation Costs in 2014
- Komendantova, N., Vocciante, M., Battaglini, A., (2015). Can the BestGrid Process Improve Stakeholder Involvement in Electricity Transmission Projects? *Energies*, 2015, 8, 9407-9433, doi: 10.3390/en8099407
- Larsson, S., Ek, E., (2003). Black-out in southern Sweden and eastern Denmark, September 23, 2003. Svenska Kraftnät, the Swedish Transmission System Operator.
- Poljanšek, K., Bono, F., Gutiérrez, E., (2011). Seismic risk assessment of interdependent critical infrastructure systems: The case of European gas and electricity networks. *Earthquake Engineering and Structural Dynamics Volume 41, Issue 1, January 2012 Pages 61–79*
- Simonsen, I., Buzna, L., Peters, K., Bornholdt, S., Helbing, D., (2008). Dynamic Effects Increasing Network Vulnerability to Cascading Failures. *Phys.Re.Lett.*100, 218701 (2008)
- UCTE (2006). Final Report: System Disturbance on 4 November 2006. Union for the Coordination of Transmission of Electricity
- UNISDR (2013). Global Assessment Report on Disaster Risk Reduction. United Nation Office for Disaster Risk Reduction, Geneva, 2013.
- UNISDR (2005). Implementing the Hyogo Framework for Action in Europe: Regional Synthesis Report 2011–2013. United Nations International Strategy for Disaster Reduction, 2005.
- UNISDR (2005). Hyogo Framework for Action 2005-2015: Building the Resilience of Nations and Communities to Disasters. United Nations International Strategy for Disaster Reduction, 2005.



## 2.2. Slovenia: Icing in 2014

Matjaz Kersnik, Electro Lubliana

### Abstract

Severe icing caused a big power disturbance in Slovenia in February 2014. This paper outlines the circumstances that led to the icing, the damage caused over a large territory and the main ensuing problems, the extreme duration of the disturbance, and how the problems were managed. The conclusions and possible solutions for future mitigation of disturbances of electricity disturbances due to extreme weather conditions are provided.

### Introduction: weather conditions

At the end of January 2014 there was a red alert in Slovenia for extreme weather conditions. The storm caused the biggest damage of the century with severe icing over almost the whole of the country. In many places the higher than average rainfall froze immediately on contact with the ground and electrical facilities, leading to massive damage. In some places the layer of ice was several centimeters thick. This was too heavy for many trees and power lines and there was major damage to the overhead lines. Figure 30 shows the first days of the storm:

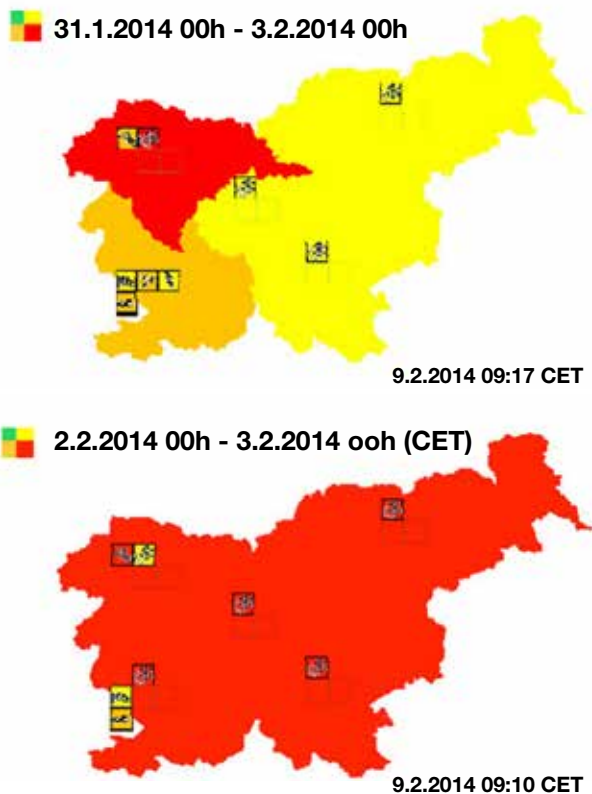

Figure 30. Rates of weather risk in colors, red representing the highest level and yellow the lowest.

Source: ARSO, National Meteorological Service, Bureau of Meteorology



Figure 31. Broken overhead network lines

Source: Elektro Ljubljana

The consequences were catastrophic and the authorities announced a state of emergency. Damage occurred to overhead transmission lines (400 kV, 220kV, 110kV), overhead distribution lines (110kV, 20kV), and LV (up to 1kV) lines for a total length of more than 1,000 km. About 5,000 x 20/0.4kV substations were affected. Over 250,000 people were without electrical power, and some were left completely without electricity for over 10 days. After the blackout, some parts of the networks were found to have been totally destroyed and only emergency electricity from diesel generators was available until the end of April. In total, over 100 diesel generators up to 1MVA were used to generate electricity. At the peak, over 1,500 workers from electrical distribution companies and other emergency services, such as civil protection, fire fighters, army, as well as volunteers, construction companies, and foreign expert workers were working together to reestablish the supply of electric power to at least the cities and bigger settlements. The estimated damage to the electricity distribution network was estimated at €70 m

The communications lines failed almost immediately because the GSM base stations had no power, and in due course the station batteries also ran out. Because of the failure on the 110kV lines, the FM signal also disappeared. There was no information on the situation. As there was no remote control



**Figure 32. Emergency restoration structures (ERS)**

Source: Elektro Ljubljana

everything done manually. To repair damage, fault handling was carried out working from high to low voltage.

For some important HV overhead lines, modular Emergency Restoration Structures (ERS) were used temporarily to bring electricity to 110kV/20kV transformer stations. Using ERS to repair damaged high-voltage overhead power lines allowed quick and effective recovery after the extreme weather conditions damaged the towers; ERS is a quick way of temporarily replacing damaged lines after natural hazards strike. It also allows the owner of the high voltage overhead power line to systematically prepare for permanent recovery via problem analysis, development of new documentation, high quality preparations for construction, and construction of new high voltage overhead power towers. It also allows for regular inspections and dealing with faults detected on high voltage overhead power line towers or consoles (brackets). Elektro Ljubljana uses ERS for damage of this nature. Other damage was treated as routine damage. But the number of faults and the highly difficult circumstances over the country caused many problems.

Applying the ERS approach creates a number of challenges and issues, that need to be addressed to ensure an effective response and crisis management, most importantly:

- Timely activation of maintenance personnel
- Effective management of staff

- Providing sufficient numbers of specialists for implementation
- (Regional) Cooperation with foreign specialists
- Public response
- Availability and satisfactory condition of work equipment, including personal safety equipment and materials
- Transportation and logistics
- Functioning communication systems (FM, GSM)
- Keeping records of the works, material consumption, and final remediation of defects
- Keeping records of aggregates, fuel consumption, and consumers connected on aggregates
- Deployment of volunteers and retirees
- Organization of nutrition and rest times
- Contractual relationships with hired maintenance workers
- Documentation for work safety and full compliance with security measures and rules

In the following, after explaining each of these challenges, we will examine how in our case study, they were addressed.

Worker activation implies a rapid response to disturbance messages and takes place at the level of the unit or company. In this case, response was 10 minutes or less in some areas. Companies and operators monitoring events are responsible for setting response times. Staff deployment, number of specialized staff, and where they operate depends on the extent of the emergency. For instance, some staff initially work independently, then get deployed to a higher level. Local coordination played an important role in this case because of the exact knowledge locals had of the terrain.

Extensive damage needs clear and coordinated management and operation of active Distribution Control Centers: the local distribution control centers are particularly important. The number of active workers includes all available workers, and also non-technical staff who helped in locating errors. Foreign workers (civil protection, fire fighters, military, construction contractors, foreign technical groups, cutters, aid from other electro-distribution companies, aid from abroad) in the most affected area can exceed the local workforce by 500%. In the first week over 1,500 workers were deployed simultaneously at different sites (distribution and foreign workers). Good cooperation was established especially with the locally based contractors, who were familiar with the terrain. The language barrier with foreign workers turned out to be an obstacle, as did the fact that contractors selected through a tender are not necessarily familiar with the terrain, which means additional preparations are needed. Local staff turned out to be insufficient in numbers because local experts also had to lead foreign workers.

While the public response, notably in rural areas, was mostly positive and sympathetic, the scope of work achieved would not have been possible without foreign assistance.

The availability and condition of work equipment was more or less sufficient. It was also used by non-professional staff, who usually do not have adequate equipment for fieldwork. To guarantee work safety, personal protective equipment (PPE) has to be available to all maintenance staff. The fact that PPE was widely available and could be supplemented wherever additional equipment was needed showed how effective the functioning and organization of the health and safety department actually was.

Transportation was a challenge as many roads were closed due to the extreme weather conditions. It is recommended that in future all vehicles should be equipped with four-wheel drive to be able to negotiate roads that are closed to regular traffic.

The availability of material in the first days of the event was poor, mainly due to a low level of emergency stocks. Some material intended for other investment projects was used. Later on, efficient procurement of supply logistics was in place. Handling supplies through a centralized warehouse with sufficient stock levels improves logistics.

When some of the *GSM base stations ran out of power supply, FM/GSM based communication were used*. At first it was only possible to use satellite phone communication. Failure of the 110 kV lines meant there was also no longer an FM signal or optical telecommunication and consequently no FM communication and remote control. After a while the batteries at the transformer stations were discharged and there was no information on the situation of SCADA. It was necessary to manually check the position of switches and work fully in manual mode. It was also not possible to use data links for exchanging information. As a result, there were some parts of the country left without communication with the rest of the world for 10 days.

Record-keeping of the works, material consumption, and needs for the final remediation of defects (plan) was problematic in that different companies used different record keeping systems (different IT support and strategies). The situation improved later after a certain level of regulation was implemented. A common problem was a lack of staff to collect and record defects.

Further complication was caused by additional informational requirements of ministries, agencies, DSO, and other institutions. They requested information, but sometimes even they did not know what they wanted and why. Each entity would request information but often lacking clear definition and specification on the level or content of the information needed.

Keeping records of aggregates, fuel consumption and consumers connected on aggregates posed challenges in terms

of monitoring aggregates and fuel consumption. The most problems were in the monitoring of aggregates and fuel consumption. There were some failures on aggregates that had to be removed immediately. Here, too, the content and level of information to be collected was not clearly defined. In retrospect, obtaining information in general proved to be challenging. Another problem was due to rental of aggregates and migrating them at locations according to the needs. Establishing a reporting system for installed aggregates took several days.

While involving volunteers and retirees in the works build on their support, it raised concerns regarding work safety, responsibility, and liability regarding the execution of work tasks. Volunteers and retirees were mainly involved in less difficult work.

Due to a lack of staff all workers had to work additional hours and were overburdened with the workload. At a certain point, workers had to take mandatory resting periods as the lack of rest caused fatigue and threatened work safety.

Contractual relationships with hired workers include regulated contracts and written agreements. Workers were also engaged with whom contracts and written agreements had not been concluded. In fact, it was not even possible to print agreements in some areas because there was neither power supply, nor sufficient time for this work. However, these were contractors trained to work with electrical equipment that, in the past, had worked for electrical distribution companies. The issue of written agreements should be resolved before the arrival of hired workers on the ground. One option may be to create templates of a written agreement for workforce providers to collect the data of workers and sort out the legal framework beforehand.

Documents for safe work are needed at different phases of the project. During the first phase, defect localization, issuing documents for safe work was abandoned. As soon as the workers started to work in a organized manner, documents were issued on safe working practices. In areas where there was a breakdown of the electricity system, the issuing of documents for safe work began when the 110 kV power was restored. Safety instructions and measures were nevertheless carried out in accordance with the instructions. For each switch manipulation, voice communication (FM) was used, which enabled recording in the Distribution Control Centre.

Compliance with security measures and rules varies depending on the difficulty of the terrain, how extreme the weather conditions, and restrictions of movement in the forest due to forest protection concerns.

The safety instructions and measures should be implemented in accordance with the instructions as much as possible. The emergency plan should be worked out with a proposal

that provides the safety and protection of workers and the provision of emergency medical care in the case of injuries. In addition, such emergency situations demonstrate the necessity of special knowledge about territorial organization, services, and facilities.

## Conclusions

The following measures are recommended to improve responsiveness and performance in crisis situations:

- Improve the hierarchy of crisis staff and adhere to it
- Prepare local operation control centers for activation in crisis situations
- Increase the number of skilled workers during normal operations who can guide and lead contracted workers in a crisis
- Improve the fleet of vehicles and equipment
- Reorganize and create a central distribution warehouse large enough to supply the main material and organize logistics for delivery of the necessary material
- Prepare written agreements for leased workers in advance
- Lay cable networks wherever possible
- Work in accordance with the safety rules in crisis situations
- Develop methods and content of record keeping in crisis situations
- Identify what work can be carried out by volunteers and retirees
- Arrange a way of providing rest for workers facing substantial overtime and teams that are understaffed
- Develop and maintain an independent communication system (FM or similar)
- Regulate the coordination and communication of the civil protection organization and distribution companies at the national level
- Keep press releases in crisis Staff Administration Company - relief of local emergency headquarters

Natural disasters cannot be prevented. Extreme weather conditions will continue to pose a threat to energy security. A crisis can be made less painful by being prepared for the unexpected and through effective training for a faster restoration of the system.

## References

Keršnik, M., and Krešimir, B., (2015), A big disturbance in Slovenia in February 2014 caused by severe icing, CIRED Lyon 2015, 23rd International Conference on Electricity Distribution, held 15-18 June 2015

Pungartnik, T., (2013), Emergency restoration structures (Ers), acceptable solution in the maintenance of high voltage overhead lines. Proceedings of the 10<sup>th</sup> conference HRO CIGRÉ, Cavtat, 6. – 10. November 2011.

## 2.3. South-Eastern Europe: Floods in 2014

Milka Mumovic

Energy Community Secretariat

### Introduction

Ice storms, floods, and landslides hit the Balkan region in recent years with devastating consequences. Network operators from affected areas had to cope with technical constraints to repair and restore their system and with financial constraints to recover the costs and stabilize the income streams.

The recovery indicated the need to define and put in place policies and procedures for:

- Precautionary measures
- Quick response
- Restoration/reenergizing
- Managing aftermaths.

All these activities are associated with costs. Under all constraints and difficulties, the systems were restored successfully. However, the financial viability of network operator remains critical.

Recalling that network operators are regulated businesses, the network tariffs should reflect adequately all the risks associated with repair and restoration of the system against natural disaster.

### Recent natural disasters in the Balkans

In 2012 heavy snow piled up on overhead lines causing interruptions in power supply and obstructing access to damaged infrastructure. In 2014 ice storms hit the western Balkans again, causing poles and lines to fall and an interruption in supply.

In mid-May 2014 continuous, heavy rainfall resulted in extensive flooding in Serbia, Bosnia and Herzegovina, and Croatia, described as the “epic floods.”

The floods caused landslides and devastation of overhead and underground infrastructure, transformer stations, customer connections, and metering equipment. The floods affected millions and resulted in 80 casualties. The severe and widespread rains triggered over 3,000 landslides. Power supply to more than 250,000 customers was interrupted.<sup>15</sup>

15 Relief web: Balkan floods 2014 <http://reliefweb.int/disaster/ff-2014-000059-srb>



Figure 33: Recent natural disasters in the Balkans

Source: Energy Community Secretariat, Report of the Elektroprivreda Republike Srpske of the Damage on Distribution Assets

### The Balkans floods, May 2014<sup>16</sup>

In Serbia, the floods affected some 1.6 million people and resulted in 51 casualties, of which 23 were due to drowning. Around 32,000 people were evacuated from their homes. The majority of evacuees found accommodation with relatives, but some 5,000 required temporary shelters in camps established by the Government and the Serbian Red Cross. Health facilities, schools, and agricultural lands were damaged. On 15 May the Government declared a state of emergency for its entire territory.

In Bosnia and Herzegovina, over a million people were affected by flooding, almost 90,000 were displaced, and 25 casualties were recorded. The severe and widespread rains triggered over 3,000 landslides. Floods and/or landslides hit 75,000 houses, of which 25,000 were severely damaged or destroyed, and also caused extensive damage to livelihoods, health, water, and sanitation facilities. (IFRC, 21 Jun 2014)

In Croatia, the floods caused widespread power outages, water shortages, damage to infrastructure, livestock and livelihoods, and displacement. Three people were killed. Of the estimated 15,000 people evacuated, more than 7,000 were registered and looked after by the Croatian Red Cross. (IFRC, 30 May 2014). Flooding was also reported in Romania and Bulgaria (ECHO, 24 Apr 2014).

## Recovery

After the disastrous floods and landslides in the Balkans and breakdown of distribution systems supplying electricity to key public services and households, network operators did all they could to restore supply as soon as the water subsided. The scale of destruction is reflected in tens of thousands of meters damaged beyond repair, wrecked transformers and respective ancillary equipment, conductors and overhead lines, including complete destruction of spare parts and material in flooded warehouses.

It took only days after the water receded to restore the emergency power supply and connect priority facilities in affected areas. The gravity of the situation forced network operators to work day and night to prevent further devastating consequences for populations and economies.

Full restoration of network infrastructure, which was dependent on the restoration of other infrastructure and consumer facilities, took months.

### Recovery measures - assessment tools

An assessment of recovery needs<sup>17</sup> indicates that the top priority are activities for restoration of the power system and measures aimed at mitigating the consequences. This is followed by measures to manage the risks and improve the ability of the network operator to respond to a natural disaster of such or similar scale. Short-term measures included quick response and restoration. The sequence can be presented in the following steps:

**Short-term or quick-response measures** include:

- urgent relocation of key facilities away from flood-prone areas,
- provision of emergency equipment and material inventory,
- rapid rehabilitation of damaged and destroyed power lines and equipment on a priority basis,
- installation of meters and safe energizing of affected sites.

After these quick response measures aiming to provide electricity to reinstate basic social and commercial functionalities in affected areas, mid-term measures are designed and implemented to allow network operators to reduce losses due to lower electricity demand.

**Mid-term measures** include:

- replenishing the equipment and spare parts inventory used up during the emergency phase,
- reconstruct/rehabilitate and construct new power distribution facilities,

16 Report UN 23/05/2014 <http://www.un.org/apps/news/story.asp?NewsID=47879&Kw1=floods&Kw2=&Kw3=#.VriQvj2bq4>

17 Recovery needs assessments prepared by EU Delegation in Bosnia and Herzegovina, 2014 [http://ec.europa.eu/enlargement/pdf/press\\_corner/floods/140714-overview-bih.pdf](http://ec.europa.eu/enlargement/pdf/press_corner/floods/140714-overview-bih.pdf)

- restore all affected facilities to operation with a better disaster-resilience capacity,
- and rehabilitate and rebuild affected infrastructure and assets, while taking into account flood and landslide protection measures,
- and reconnect affected business premises to ensure continuation of uninterrupted business operation.

As was the case during the recent Balkans flooding, developing a comprehensive restoration plan which takes full account of access to affected areas, priority connections and pace of restoration of consumption sites and facilities is vital at this stage. In the aftermath, the lack of material, spare parts, tools and equipment was evident, partly due to the scale of destruction, partly because warehouses were damaged or destroyed. Regional neighboring DSOs provided assistance in quick response measures and later European DSOs in EURELECTRIC were asked to provide support by supplying urgently needed material and spare parts, primarily meters.

**Long-term measures** include precaution and managing aftermaths. In the long run, network operators have to tie reconstruction and recovery efforts to development and growth strategies. These strategies need to take account of the risks of natural disasters and improving resilience to them. Based on the risk assessments, the plans may include: development of quick response and full restoration plans, review of emergency procedures for the future, relocation of key facilities away from known flood areas, new design parameters and/or practices for energy infrastructure and assets to improve performance and resilience, and strategically located emergency equipment and material inventory such as mobile substations.

Massive damages to customer facilities led to substantial decrease in demand requiring network operators to revise not only their development plans but also the capacity requirements from the reconnected facilities.

## Tool to assess financial viability of restored networks

After returning to business as usual, network operators need to assess their position before and after the disaster, analyze the procedures and measures applied and their effectiveness and to adjust policies and procedures accordingly. Immediate financial consequences include costs of repair of equipment and rehabilitation, writing off and disposal of equipment, costs of procurement and installation of new and replacement equipment, and lost revenues.

Damaged equipment must be urgently examined and repaired whenever possible. If repair is not possible or not reasonable, the equipment will be disposed of and replaced. A network operator should have a transparent procedure in

place to conduct such an evaluation. In principle, an asset should be repaired if the fair value of the repaired asset will exceed the book value, whereas the book value equals the sum of net book value and costs of repair.

**Costs of repair and disposal** include used material, engagement of staff and equipment, transport and field work of staff and outsourced services of third parties. In the given circumstances, the costs are usually higher compared with a similar scope of work in regular course of business. Repair and rehabilitation costs are reflected in the company's accounts as costs for the period. If a company does not have insurance coverage or a dedicated contingency fund, the costs of the period in question are likely to rise significantly. The assets damaged beyond repair have to be written off to zero and accounted for at net book value. These are one-time costs, eventually adjusted for a salvage value, if any, and costs of disposal, which may include dismantling, transport, and restoration of the site, in line with company accounting policies.

**Replacement** is when new equipment is installed to replace destroyed equipment, taking account of updated design parameters to improve resilience. All expenditures incurred to put new assets in place and condition for their intended use are capitalized (i.e., registered as fixed assets). This acquisition will not have an immediate effect on the profit and loss account of the current year, as the asset is depreciated over its useful life.

In times of disaster, companies receive donations and grants, either monetary or in kind. It is important to account for everything received – to determine the fair value of received assets in kind and to account for all related costs of acquisition, such as transport, installation, trial run, etc. Grants are important because received assets do not give rise to operational expenses. In the short term, grants and donations of equipment alleviate the financial position of a network operator and the pressure on network tariffs, as donated assets should be factored out when tariffs are being set.

**Lost revenues** are connected with a prolonged outage and also have indirect devastating consequences. Electricity is not supplied to customers and consumption is not registered until metering equipment is installed. Revenues are not incurred during the period when services were not supplied and the fixed costs of the period are not covered. If the company does not have insurance or contingency coverage to bridge the emergency expenditure and lost revenue, its viability will be endangered. It is not only the network operator that loses revenues. All other economic operators in the affected area are prevented from operating and earning income. Indirect damages are estimated using different methodologies, but for the electricity network, the key indicator is the value of loss load. The value of lost load is the estimated value that customers attribute to security of electricity sup-

ply measured as the amount they would be willing to pay to avoid a disruption in their electricity service. This estimate may be used to determine the social costs and benefits of measures to improve resilience and reduce natural hazard.

**Insurance of distribution equipment and policy** is a matter of internal economics. For a network operator insurance should at minimum cover the risks of regular operation. Extending the coverage to situations declared as a state of emergency and natural disasters is not very common. The decision will be based on a well substantiated cost–benefit analysis, taking into account overall impact on cost of service and value of lost load.

Network operation is a regulated business and consequently decisions related to insurance coverage will depend on a regulatory assessment. A network operator will not incur costs which cannot be recovered from tariffs. On the other hand, it is the responsibility of network operators to evaluate costs and benefits in different scenarios for insurance coverage.

## Summary

A network operator, as a provider of an important public service, has to take due care of network security and costs of operation. Keeping the two in balance requires a comprehensive analysis and assessment of different scenarios, keeping up to date with scientific and technological achievements and implementation of best practices. Regulatory oversight and approval is part of the process. A network operator must strive to substantiate its proposal with sufficient evidence for an informed decision. The priorities are:

- permanently check and upgrade emergency and restoration plans;
- explore lowest cost options to minimize damage to existing energy assets in the future;
- review insurance policy and assets insurance coverage;
- and analyze cost efficiency of design parameters for improved resilience solutions and revised development plans.

## 2.4. France: Storms in 1999

Eric Andreini,

Réseau de Transport d'Electricité (RTE)

### Introduction: Natural Disasters - reality and increasing risks

Under climate change, natural disaster events tend to be more unpredictable, frequent, and devastating for critical energy infrastructure. Since 1999 France has experienced

several storms that have severely impacted its electricity network. The two most important, Lothar and Martin, happened on 26 and 27 December 1999 with winds of nearly 200km/h (Figure 34).



Figure 34: consequences of natural disasters

Source: RTE library

Each year between 2009 and 2012 there was a storm with an impact on the network: Klaus - January 2009: comparable in terms of wind power with Lothar and Martin, it damaged four times fewer towers than in 1999, Joachim - December 2011, Andrea - January 2012, and Foehn - April 2012, affected the grid by winds in excess of 110 km/h, with minor damages.

This is why Transmission System Operators (TSOs) must take into account the natural disasters in their development and maintenance strategies for the electricity networks.

### Consequences of natural disasters on electricity networks

Electricity transmission networks consisting mainly of overhead lines, cables, and pylons are particularly sensitive to storms and strong winds and falling trees. This results in interruptions in energy supply which can be very long because of the major repair works needed (Figure 36).

France had never experienced such storms previously. As shown in the above table, the consequences were serious, but the network showed a good level of resilience: only 0.5% of

## December 1999

First storm  
Lothar (25–26)

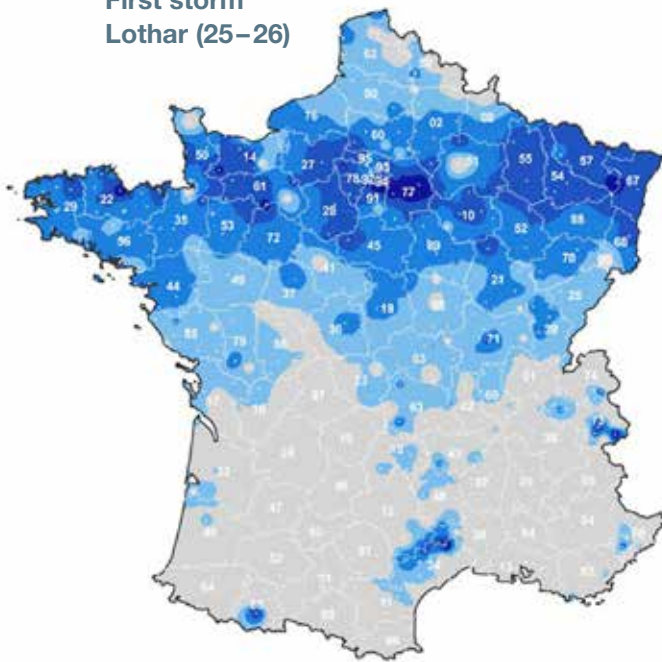

Second storm  
Martin (27–28)

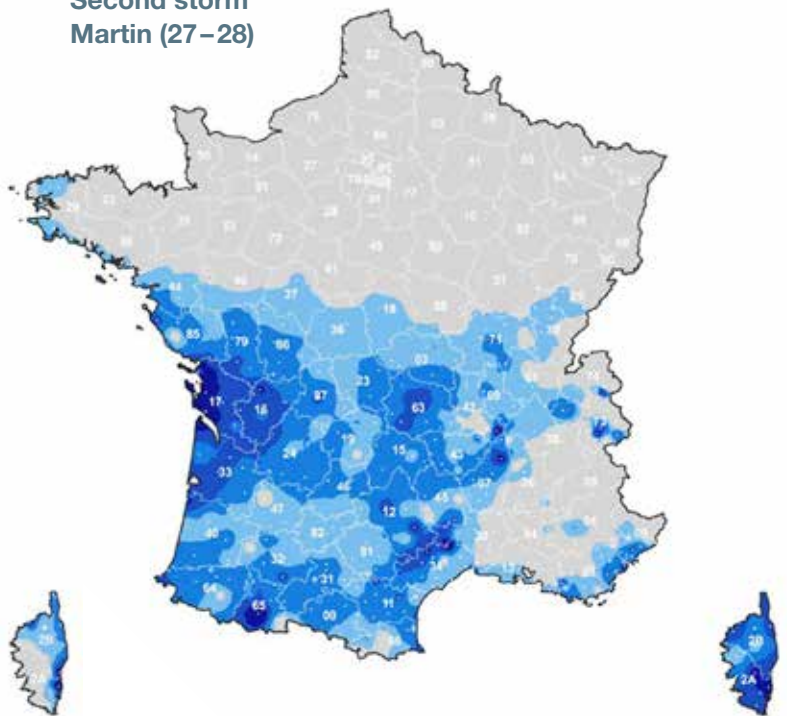

Vent maximal instantané



Figure 35. Key figures of those storms: wind speed from blue to red

Source: Meteo France

the total number of towers were affected. This does not seem much, but around 10% of the circuits and more than 180 substations were out of order for five days or more. Hence, the fundamental importance of power system resilience against the consequences of natural disasters to the network.

### Implementation of technical issues to strengthen the network: The mechanical strength program

Following these events, RTE decided to implement a new mechanical upgrading of its network based on i) increasing the hypothetical wind pressure at the design stage; and ii) implementing anti-cascading towers every 5 km to limit damage. The goals of these measures are: i) continuity of the service; even if another 1999 storm occurs, transmission lines must keep on supplying “source” substations; ii) restoration of the service if a bigger storm hits; the delay both in resupplying “source” substations and ensuring the security of the public must be overcome, as infrastructure damages have consequences for both energy supply and safety in public areas. In order to face recorded wind speeds of around 200km/h and more in areas where RTE had never before recorded more than 160km/h, the technical upgrading is the subject of a new technical law.

VOLTAGE	DAMAGE	CAUSE
63/90 kV 300	destroyed	50% Wind
421/4900 circuits out of order	500 damaged	50% Wind 50% Trees
225 kV	125 destroyed	90% Wind 10% Trees
81/1050 circuits out of order	25 damaged	50% Wind 50% Trees
400 kV	120 destroyed 5 damaged	100% Wind
38/450 circuits out of order	5 damaged	100% Trees

Figure 36. Key statistics of the consequences of the 1999 storms: (damage = number of towers)

Source: Data, RTE

### A new “technical” law (2001) with three “legal” wind pressures:

- Normal wind (inland): 570 Pa on conductors (+20%) (previously, 480 Pa)
- Strong wind (some regions): 640 Pa
- Very strong wind (coastline/river-crossing): 720 Pa

“Anti-cascading” towers must be erected every 5 km: to avoid big cascading failures and to allow quick restoration thanks to temporary lines (5 km long).





Figure 37: Emergency restoration training and cooperation

Source: RTE library

### Results:

All the proposed provisions were completed by the end of 2010: treatment of 1,395 x 400kV towers, treatment of 842 tower foundations, and expansion of 8,400 km of forest corridors

Based on the feedback, the following goals were achieved:

- Ensure that at each delivery point RTE has a secure power supply line, resistant to winds of an intensity equivalent to that of the 1999 storm. The item qualified “complete security” concerns around 2,500 points of secure deliveries, 48,700 km grating (3700 lines) which constitute the securing of the target network. At the end of 2012, approximately 61% of delivery points and 74% of the target network lines were secure.
- Strengthen the important road crossings and overlooking areas. This item concerns brought about 8000 and is made up to 80% at end 2012 and end in 2017.
- Reconnected each delivery substation cut in five days in case of exceptional events.

The program should be completed by 2017. The mechanical security program the implementation of which started in 2002, was funded to the tune of €100 million/year until 2007 on RTE’s operating budget. From 2008 this deployment has accelerated to reach 185 million €/year (excluding investment). RTE’s investment program over the network contributes about 20% to the development of security policy.

### Emergency restoration training and cooperation:

RTE has made a commitment to the French state to restore power to the substation within five days at the most. Emergency restoration organization is then implemented and based on crisis management, 400 and 225 kV temporary lines, and regular team training exercises. RTE signed the GO15 Protocol Agreement for Mutual Assistance in November 2012.

## 2.5. Resilience of Electricity Networks to Natural Disasters

Wei Liu,

Human and Environment Linkage Program

### Introduction

In modern societies, electricity transmission networks, one of the critical components of the lifeline systems, play a vital role to supply energy to support national and regional economies and people’s daily lives. Reliability of these networks, often high dimensional, is essential to the security of energy supply, or even national security. As the electricity networks grow, they face a variety of threats, among which the top is natural hazards, such as earthquakes, tsunami, floods, landslides, et cetera. Natural disasters may disrupt or damage critical lifelines, such as electricity networks, with serious effects beyond the losses suffered directly by the utility or electric system operators. Electricity is essential to maintain the functionality of emergency services and other lifelines such as water supply, fuel supply, and communications, and also plays a major role in the economic vitality of the community. Failure of electricity networks in a disaster may cause not only huge direct/indirect economic losses, but also severely impact people’s normal life and social production, or even trigger a cascade of economic, social and environmental in today’s highly complex and interconnected societies. Rapid restoration of electricity network is critical to the recovery of a disaster-stricken region. Therefore, discussions about resilience of electricity networks become essential in regions and countries with significant natural hazards and also in the context of climate change.

### Multiple perspectives of resilience

In this section we briefly review a variety of perspectives on resilience from different disciplines and discuss how they relate to the protection and resilience of electric power networks and other critical infrastructure systems.

## Engineering and material resilience

Engineering resilience is probably most commonly known to general public. Davoudi (2012, pg. 300) defined it as “the ability of a system to return to an equilibrium or steady-state after a disturbance...such as flooding or earthquakes, or a social upheaval, such as banking crises, wars or revolutions”. The level of resilience is proportion to the speed of bouncing back. In material science, resilience refers to the ability of a material to absorb energy when it is subjected to strain, without being permanently distorted. And the more energy a material can absorb before reaching the maximal elasticity limit, the more resilient it is. Holling (1996, p. 33) points out that engineering resilience “focuses on efficiency, constancy, and predictability – all attributes at the core of engineers’ desires for fail-safe design.”

## Ecological resilience

Holling coined the term ecological resilience and defined it as “a measure of the persistence of systems and their ability to absorb change and disturbance and still maintain the same relationships between populations or state variables” (Holling, 1973, p. 14). He stresses the concepts of persistence, change, and unpredictability in this definition, in contrast to efficiency, constancy, and predictability in engineering resilience. A resilience ecosystem has the capacity to absorb disturbance (e.g., fire, pest) and reorganize while undergoing changes.

## Other disciplines – psychological, social and economic Resilience

The concept of psychological resilience originated from both child/youth development and epidemiology. It is about the ability of an individual to maintain physiological and psychological health in the face of a traumatic/adverse event and recover from it. It has also been expanded to the concept of community resilience, which looks at the collective ability of community members to cooperate and thrive in an unpredictable environment (Welsh, 2013; Berks and Ross, 2013). The latter is also related to the emerging social resilience perspective (Adger et al. 2000; Keck & Sakdapolrak, 2013), which stresses for the coping, adaptive and transformative capacities of communities facing changes and shocks. In economics, resilience is generally related to how the ability of markets to maintain function (e.g., continue producing or growth) when shocked by recession, change in consumer preferences, damage to capital (e.g, disasters), et cetera. Economic resilience necessitates a stable and effective macroeconomic and institutional environment and efficient market, along with social development (Rose, 2007).

## The emerging social-ecological resilience

Partly building on Holling’s work on ecological resilience, the concept of social-ecological system resilience was recently developed together by natural and social scientists. Resilience Alliance defined it as “the capacity of a social-ecological system to absorb or withstand perturbations and other stressors such that the system remains within the same regime, essentially maintaining its structure and functions. It describes the degree to which the system is capable of self-organization, learning and adaptation” (RA 2015). The social-ecological system perspective sees that human societies, the physical world, and the biosphere are all interconnected and considers resilience thinking an important part of the solution to sustainable development because it strives to build flexibility and adaptive capacity in the longer term and enable people to anticipate change and influence future pathways, instead of focusing on optimizing short-term system performance and/or efficiency.

Building on the abovementioned perspectives, we propose that a more holistic framework for building the resilience of electricity networks to natural disaster should (1) consider the electricity networks as both the physical components and their human individuals and organizations that operate the systems, (2) see electricity networks embedded in a broader regional or national social-ecological setting, and (3) identify resilience as being able to maintain functionality and recovery capacity in face of future disasters and continue improving using experience learned from disaster events that occurred.

## Four properties of resilience and its implication for protecting and building resilient electricity networks

While the resilience of a system is often place-, scale- and context-specific, some general properties or principles do exist. In this section we briefly introduce four main properties that have been identified in various resilient systems (Cimellaro et al., 2010), namely the four Rs – robustness, redundancy, resourcefulness, and rapidity. Cimellaro et al defined them as following -

- **Robustness:** strength, or the ability of elements, systems, and other measures of analysis to withstand a given level of stress or demand, without suffering degradation or loss of function.
- **Redundancy:** capacity of satisfying functional requirements in the event of disruption, degradation or loss of functionality.
- **Rapidity:** the capacity to meet priorities and achieve goals in a timely manner in order to contain losses, recover functionality and avoid future disruption.
- **Resourcefulness:** the capacity to identify problems, establish priorities, and mobilize alternative external re-

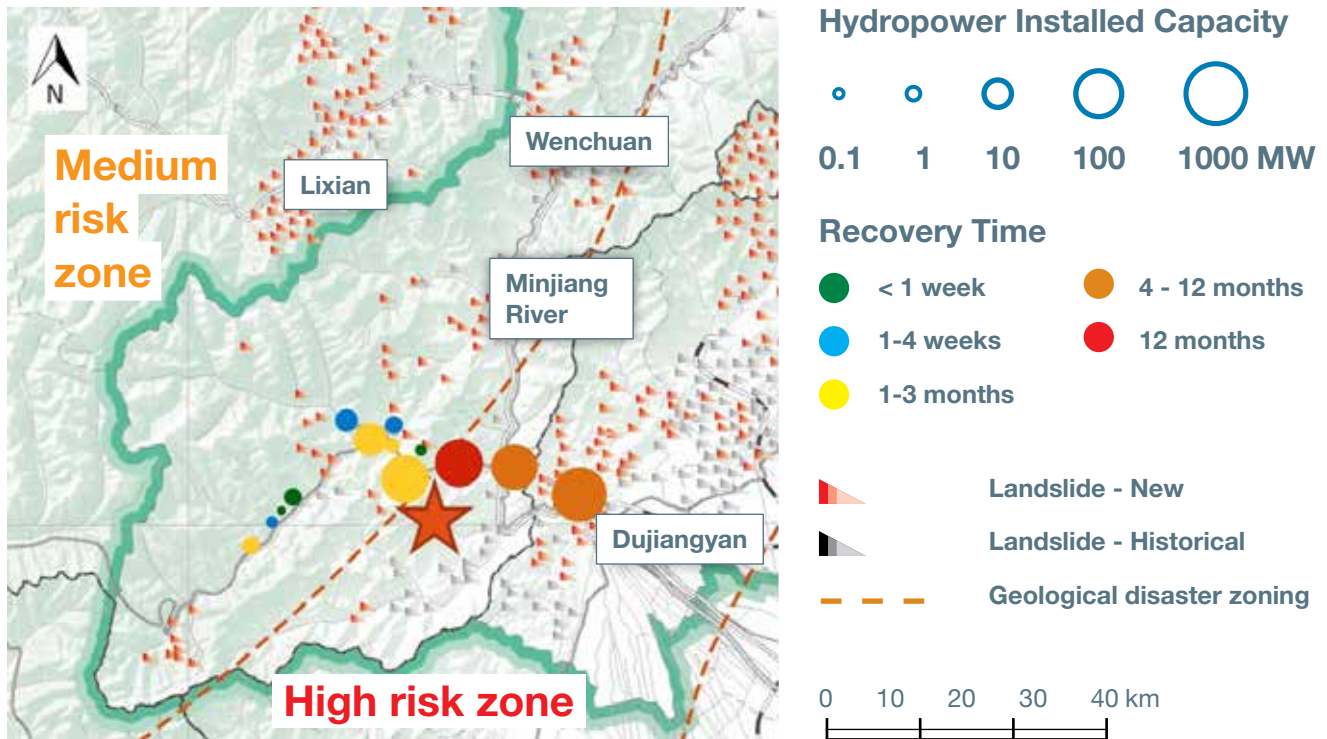

Figure 38. The electricity generating and transmission systems in hazard-prone areas of Wenchuan County, Sichuan, China near the epicenter of the 2008 Wenchuan earthquake.



Figure 39. Damaged Gengda Hydropower Plant (left) and nearby substation (right) near the epicenter of the Wenchuan Earthquake (Photo credit: Mingchong Liu).

sources when conditions exist that threaten to disrupt some element, system, or other measure.

These four properties are highly relevant in the context of the resilience of electricity networks to natural disasters. Current discussions on electricity network resilience mostly pay attention to the **robustness** of the physical components, such as substation equipment and transmission lines and towers, and focus on correcting design issues such as poorly detailed, improperly restrained, or unanchored equipment that are vulnerable to disasters such as earthquakes and landslides. A robust electricity network should also include robust human

resources, which include trained personnel and organization with necessary knowledge and experience to operate the system during emergency and recovery periods. **Redundancy** refers to the extent to which alternative elements, systems, or other measures exist, that are substitutable for the existing ones. For electricity networks, this could be either back-up physical equipment, and having extra personnel or training them to have multiple skillsets to operate the system. **Rapidity** refers to how fast related organization and personnel can respond to disaster during emergency and also how quickly a network's functionality can be recovered if certain damage is unavoidable. Rapidity also takes account of learning, such

as how soon an electricity network operating organization can learn from a disaster event and be better prepared for the next event, and may involve a transformation. **Resourcefulness** means the ability to mobilize material (i.e., financial, physical, technological, and informational) and human resources to the whole process of disaster risk management and resilience building. Resourcefulness, often through making financial and organizational decisions to engage additional and alternative resources, could help improve robustness by replacing legacy equipment and supporting structures with more modern and disaster-robust equipment and structures to prevent and reduce disaster risk; create redundancy by providing resources to maintain additional equipment and personnel; and enhance rapidity *ex post* by making relevant investment *ex ante*.

### Resilience of electricity networks in the Sichuan earthquakes in China

Mountains in the Western China province Sichuan lie at the eastern edge of the Qinghai-Tibet Plateau, where several of the largest rivers in Asia originate from and feed tens of millions people downstream. The province has great potential in hydropower, with a gross theoretical capacity of 143 million kW (ca. 21% of the national total capacity of China) and a technical theoretical capacity of over 100 million kW. The total installed capacity of hydropower in Sichuan has recently reached 63.7 million kW, supplying electricity to both within and outside of the province. The mountainous area in Sichuan is also a global hotspot of earthquake and landslide disasters. Through recent human history dozens of large earthquakes have been recorded in this region and landslides and flashfloods are common, especially in summer monsoon seasons (Xing and Xu 2010).

The Mw 7.9 (Ms 8.0) Wenchuan Earthquake at 14:28 on May 12, 2008 was the most devastating earthquake in mainland China in the past 60 years, and resulted in the most serious losses and damages with the largest stricken area of about 500,000 km<sup>2</sup>. At least 69,227 people were killed, 374,643 injured and 17,823 missing during the earthquake, while about 15.1 million people in over 400 counties (cities or districts) in 10 provinces (municipalities or autonomous regions) needed to be urgently relocated (Xing and Xu 2010). The earthquake severely destructed regional infrastructures, including the electricity system. Besides damages to dozens of hydro and thermal power plants (such as those near the epicenter shown in Fig. 1 and Fig. 2 left), the regional high voltage power transmission network and local distribution systems were also seriously destructed (see pictures in Fig.2 right). A total of 2.46 million users suffered power outage. There was widespread failure of the water supply in the quake-stricken area due to lack of electricity for pumps and other equipment. Half the wireless communications were lost in Sichuan, partly because of power

disruption that prevented thousands of base stations from functioning (Chen and Booth 2011).

The Wenchuan Earthquake posed an unprecedented challenge to electricity network in Sichuan, and to the whole energy industry in China as well. The lack of resilience in the electricity network system apparently was a critical factor behind the severe losses and damages and indirect impacts. The physical network was not robust enough to sustain the impacts of the earthquake and quake-induced landslides. In areas near the epicenter, the seismic intensity reached XI, much higher than the specified seismic intensity level (mostly at VII) in the design of the networks. Three 500kV-electricity transmission lines and 56 220kV lines tripped after the earthquake and 122 110kV-lines, and 110 35kV-lines and 795 10kV-lines suffered outages, mainly due to fallen pylons, broken poles, and damage to transformers, circuit breakers and other high voltage equipment (Eidinger 2009). The electricity network operators were not prepared to such an event either, due to the lack of emergency response plans and related knowledge and experience. The level of redundancy in both equipment and personnel was also low, partly due to the fact that historically investment and development in electricity transmission network significantly lagged behind the construction of power plants. While the level of general resourcefulness of the country was high and the government rounded up huge amount of financial and human resources into the earthquake relief and recovery processes, the electricity network across the vast quake-stricken areas did not return back to basic functioning till weeks or even months later, a sign of lack of rapidity. The reconstruction of the whole electricity network in the region only finished five years later.

Taking the hard lessons from the Wenchuan Earthquake, about 26 billion Yuan (~4.2 billion US Dollar) were invested in reconstructing a more resilient electricity network system in Sichuan by 2013 (SGN 2013). Modern seismic design guidelines were taken into account to rebuild the power systems, such as reducing the fragility of equipment and constructing substations outside landslide zones so that these equipment can sustain a higher level of seismic intensity. More importantly, a new electricity network disaster emergency and risk management system was designed and implemented by the State Grid Sichuan Electric Power Corporation, covering disaster risk prevention, preparation, response and recovery stages (CPNN 2015). This new system was soon tested in the Ms. 7.0 Lushan Earthquake on April 20<sup>th</sup>, 2013. The epicenter of this Mw 6.6 (Ms 7.0) earthquake was just 85 km southwest to the Wenchuan Earthquake epicenter, with a highest seismic intensity measured at IX. Although less devastating than the Wenchuan Earthquake, the Lushan Earthquake still affected around 2 million people in over 100 counties and caused substantial damages to lifeline systems. Some similar damages to electricity network equipment was

still observed, mainly in high landslide risk locations; but the overall emergency response was much improved (Chen 2013). Electricity supply to the centers of the three counties closest to the epicenter were all recovered only one day later, and it took only 20 days to recover electricity supply to all affected villages. The success shown in the Lushan Earthquake response and recovery was largely due to the resourcefulness of the central and provincial governments, which have the capacity to mobilize large amount of human and financial resources, and also the rapidity of learning by all sectors from the Wenchuan Earthquake.

The Wenchuan Earthquake and its reconstruction is a milestone in China's disaster emergency and risk management history and also a critical event that changed the trajectory of China's power network system development toward resilience building. While significant improvement has been achieved in mountainous Sichuan, as evidenced by the Lushan Earthquake, the nature of mountainous Western China being hotspot of various disasters make it a long-term challenge to build resilience electricity network and other lifeline systems for millions of households in this least developed region of the China.

## Conclusions

In summary, we reviewed key perspectives on the concept of resilience in various disciplines, including engineer, ecology, psychology, economics and social-ecological systems, building on which we propose that the resilience of critical infrastructure systems, such as electric power network, to natural disasters should include both the physical capacity of the power systems (transformation substations, transmission lines, etc.) and the organizational capacity of the operating groups. We further elaborated four necessary properties, robustness (ability to withstand a shock), redundancy (functional diversity), resourcefulness (ability to mobilize when threatened), and rapidity (ability to contain losses and recover in a timely manner), of a resilient system, and demonstrate how each of them can be operationalized in the context of maintaining reliability of electricity networks and other critical infrastructure systems in a more and more interconnected world facing increasing frequency and intensity of natural hazards. We demonstrated how the concept and properties related to disaster resilience of electricity network system can be operationalized using the case of 2008 and 2013 earthquakes in Sichuan, China.

## References

Adger, W. N. (2000). Social and ecological resilience: are they related?. *Progress in human geography*, 24(3), 347-364.

Berkes, F. & Ross, H. (2013) Community resilience: toward an integrated approach, *Society and Natural Resources* 26: 5-20.

Chen, Y., & Booth, D. C. (2011). *The Wenchuan earthquake of 2008: anatomy of a disaster*. Springer Science & Business Media.

Chen, A. (2013). "On the importance of modern emergency management: Lushan Earthquake and Wechuan Earthquake (从芦山地震和汶川地震看现代应急管理的重要性)." *Science and Technology Review* 31(12): 11.

Cimellaro, G., Reinhorn, A. & Bruneau, M. (2010) Seismic resilience of a hospital system, *Structure and Infrastructure Engineering* 6(1-2), 127-144

CPNN (2015). State Grid Sichuan Electric Power Corporation raises emergency management capacity in four steps (四川电力四步骤提升应急处置保障能力). *China Power News Net*. Retrieved March 29th, 2016.

Davoudi, S. (2012) Resilience: A Bridging Concept or a Dead End, *Planning Theory and Practice* 13(2): 299-307.

Eidinger, J. (2009). Wenchuan earthquake impact to power systems. In *Proceedings of the 2009 technical council on lifeline earthquake engineering (TCLÉE) conference: lifeline earthquake engineering in a multihazard environment*, Oakland, June.

Holling, C. (1973) Resilience and Stability in Ecological Systems, *Annual Review of Ecology and Systematics* 4: 1-23.

Holling, C. (1996) Engineering Resilience Versus Ecological Resilience, *Engineering Within Ecological Constraints*, ed.: Peter Schultz, National Academy Press, Washington D.C., pp. 31-43.

Keck, M., & Sakdapolrak, P. (2013). What is social resilience? Lessons learned and ways forward. *Erdkunde*, 5-19.

RA (2015). "Resiliencia Alliance key concepts: Resilience." Retrieved March 15th, 2016, from <http://www.resalliance.org/resilience>.

Rose, A. (2007) Economic Resilience to natural and man-made disasters: Multidisciplinary origins and contextual dimensions, *Environmental Hazards*. 7 (4): 383-398.

SGN (2013). Completion of the electricity network reconstruction in Wenchuan Earthquake stricken regions ("5-12"汶川地震灾区电网重建工作全面完成). *State Grid News*.

Welsh, M. (2013) Resilience and responsibility: governing uncertainty in a complex world. *The Geographical Journal*.

Xing, H., & Xu, X. (2010). *M8.0 Wenchuan Earthquake* (Vol. 123). Springer.

You, H. and F. Zhao (2013). Analysis of the causes of damages to power facilities in the M7.0 Lushan Earthquake (芦山7.0级地震及电力设施破坏原因分析). *Electric Power Construction* 34(8): 100-104.



## Chapter 3

# Good practices from private and public sector stakeholders

Chapter 3 provides examples of good practices on prevention of power blackouts caused by natural disasters, which are available at the German Federal Office of Civil Protection and Disaster Assistance, to prevent long-term security of supply and to increase short-term reliability of the power system, available at GO15, the organisation bringing together several transmission systems operators. The chapter also contains perspectives of the insurance industry, provided by the Willis Towers and Willis Re, which is followed by the discussion of the early warning mechanism, provided by the Energy Charter Secretariat.

### 3.1. National Civil Protection

**Christine Eismann,**

German Federal Office of Civil Protection and Disaster Assistance

#### 1. Introduction – Electricity networks are in focus

This article highlights some of the successful measures that were implemented in Germany in order to prevent power blackouts caused by natural disasters, as well as examples of how power disruptions can be handled. Within Critical Infrastructure Protection, the German Federal Office of Civil Protection and Disaster Assistance (Bundesamt für Bevölkerungsschutz und Katastrophenhilfe, BBK) focuses on electricity networks as part of the Critical Infrastructure of “Energy Supply.” As almost all other infrastructures depend on it, failure can have dramatic consequences for the citizens (Petermann et al. 2010).

The most important conclusion from the examples is that successful risk and crisis management cannot be realized by one organization alone. Cooperation is key. Every stakeholder has a part to play. While public authorities are in the

position of defining protection goals, infrastructure operators have the lead in risk prevention within the organization; thus, each stakeholder has a different perspective and responsibility.

The examples will be presented according to the four phases of the integrated risk and crisis management cycle (see Figure 40). However, the reader should keep in mind that some of the examples touch on several phases. To deal with the risk of power failure successfully, action needs to be taken during all four phases:

- Prevention to lessen the probability and intensity of a blackout happening, decision on which risks to take and which to avoid
- Preparedness to establish structures that are able to deal with a blackout in case it occurs despite the prevention measures
- Response to keeping blackouts small and short and the degree of damage low
- Recovery to get back to normal life by building on experiences from the event.

#### 2. Prevention

Systematic prevention of the risk of power failure is achieved by performing risk management. Risks need to be analyzed, evaluated, and treated at all different levels of government as well as in companies. Some examples are now listed. The examples are chosen from the perspective of Civil Protection. Of course, the design of the legislative framework also plays an important part in risk prevention. It is, however, not in focus here.

In Germany, regular reports on Risk Analysis in Civil Protection at the National Level are presented to parliament. In the scenarios “winter storm” and “storm surge,” power blackouts are given special consideration. To catch the dependencies, power failures are treated as part of the scenario in the report. The cascading effects on other criti-

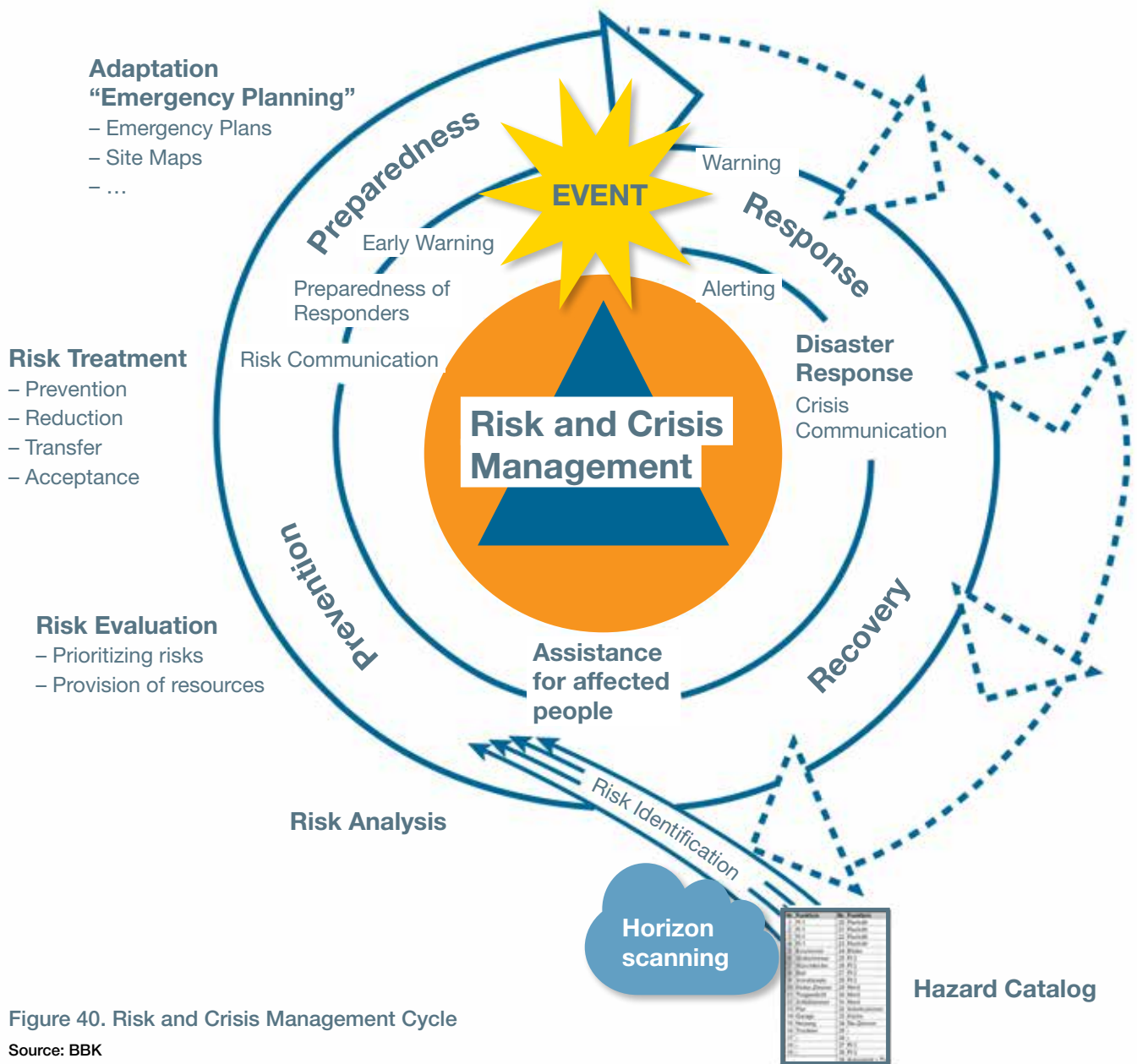

Figure 40. Risk and Crisis Management Cycle  
 Source: BBK

cal infrastructures (CI) are described on a generic level (Deutscher Bundestag 2013).

For private and governmental organizations, the German Ministry of the Interior (Bundesministerium des Innern, BMI) published a Guideline for Risk and Crisis Management in Critical Infrastructures (BMI 2011). It provides for all operators a methodology to perform a well-structured analysis of their own operability/operational capability, considering not only everyday hazards, but also extreme events. The analysis also looks at the vulnerability and criticality of infrastructures and their processes and elements. Electricity network operators who perform risk and crisis management according to the guideline add to the security of the electricity infrastructure. Other methods for risk management are also available, for example as described in ISO 31010 (ISO. IEC 31010:2009).

Operators of CI and governmental authorities – ideally – exchange information on the relevant findings of their risk analyses in order to strengthen the protection of Critical Infrastructures and therefore of the population from hazards. This cooperative approach is manifested in the German Critical Infrastructure Strategy (BMI 2009). A successful example is the Working Group on Electricity, in which the roles of the public authorities (from the interior and economy portfolios) and of the operators are defined as shown in Figure 39: The authorities supply the scenarios and the protection goals. The operators identify the processes and assets that are critical, meaning that their failure would result in large supply disturbances. They perform an analysis of the vulnerable parts in their system and define and implement protection measures. Both operators and authorities are responsible for validating the effects of those measures.



## System / Process for Public-Private Cooperation

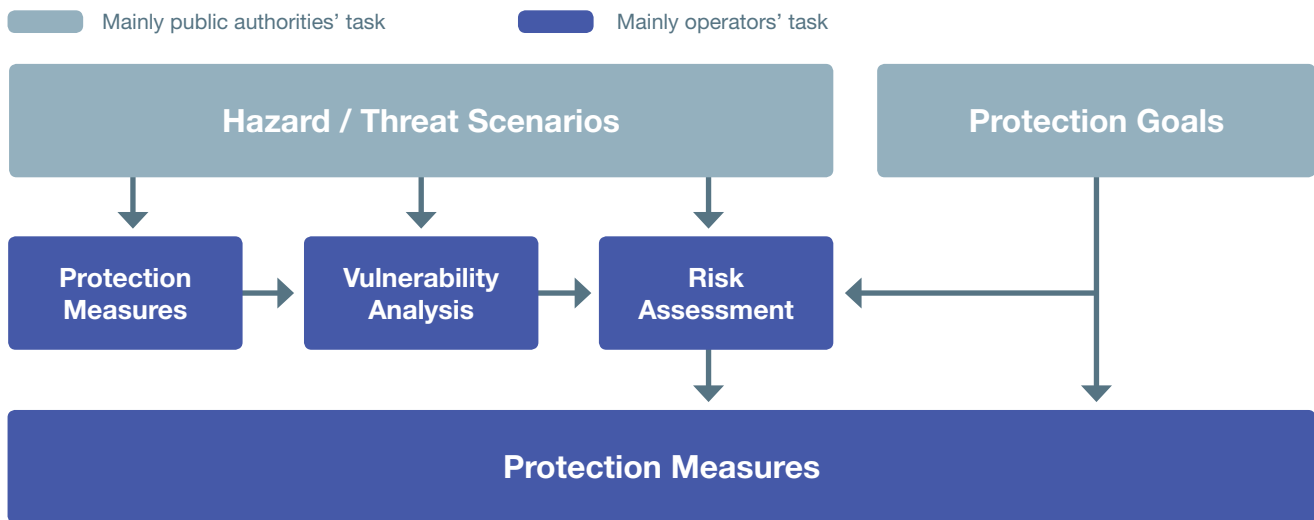

Figure 41. Assignment of tasks within the cooperative approach

Source: BBK 2012

Voluntary cooperation also takes place in the UP KRITIS, a platform on which representatives of private companies and authorities meet to discuss different aspects of critical infrastructure security (BSI 2014). It is hosted by the Federal Office for Information Security (Bundesamt für Sicherheit in der Informationstechnik, BSI). In the Sectoral Working Group for Electricity, threats, criticalities, and vulnerabilities are discussed.

Complementing the cooperative approach, in cases where equal standards and procedures are necessary, legislative solutions are needed. An example for this is the new IT Security Act (IT-Sicherheitsgesetz, ITSiG), which defines procedures for operators of critical infrastructures to report incidents to the Federal Office for Information Security (Bundesamt für Sicherheit in der Informationstechnik, BSI).

Critical infrastructures are also, protected according to the European Program on Critical Infrastructure Protection (EPCIP). For the energy sector, the 2008 Directive on European Critical Infrastructures has been implemented into national legislation. This means that the operators of European critical energy infrastructures in Germany have to prepare Operator Security Plans (advanced business continuity plans) and nominate Security Liaison Officers (linking the owner/operator with the national authority responsible for critical infrastructure protection).

The operators of the critical energy infrastructures are the stakeholders that have to implement the protection measures and that can give detailed information on viable ways to improve protection measures – both physical and by deliberate planning. The (legislative) authorities have to

provide the framework for this. A good practice example is that in the German Federal Regional Planning Act, it is obligatory to consider critical infrastructures in the stakeholder process (Raumordnungsgesetz). This serves to give critical infrastructure protection an adequate role in wider planning processes: Is centralization of power lines, which might be useful from an economic perspective, also a good idea when considering questions of vulnerability? Might transformer stations be exposed to threats due to their geographical position?

Research projects can generate input for the risk management regarding power failures. In a project funded by the German Ministry of Education and Research, the participants developed a methodology to generate threat scenarios by combining hazards with different effects. An example was the combination of flooding and a cold spell, with the low temperatures resulting in frozen water that might hit roads and houses as well as transformer stations (BBK 2014). In the same project, a simulation of an earthquake was run as an example for an extreme single risk. The simulators were able to get much more detailed information on the vulnerability of a transformer station than was previously known. The operator could therefore take well-adjusted measures (BBK 2014).

For local authorities, the BBK and the United Nations University (UNU) provide guidelines for specific scenarios that might be more frequent in the future due to climate change. The guidelines “Assessing Vulnerability to Flood Events at a Community Level” and “Assessing Vulnerability to Heat Waves and Heavy Rainfall at a Community Level” contain expedient checklists for the users. These are also on the topic of blackouts: such as the checklist on “Emergency power supply

in a flooding event” (BBK and UNU 2014). Another guideline provides checklists on “Vulnerability assessment of the municipality to power failures” (BBK and UNU, 2014). They are directed at officials, the population, emergency services, and critical infrastructure operators.

### 3. Preparedness

Risk preparedness builds closely on prevention. The focus shifts from technical and physical protection measures to planning the necessary capacities for the event that a risk materializes despite all preventive measures or because it has been explicitly taken. This is necessary because not all risks can be diminished. Preparation is, just as prevention, a part of risk management.

To be prepared, the BBK is working on emergency planning for widespread and long-lasting electricity blackouts, taking into account the preparations of all relevant stakeholders.<sup>18</sup> The goal is to bring all efforts together in a harmonized concept. This, for example, guarantees that a minimum level of supplies is available for every citizen. To get an overview of the multitude of projects being worked on in Germany’s federal system of civil protection, a series of workshops has been started by BBK.

Research projects help generate good practice solutions to keep necessary goods and services available in blackout scenarios. Examples of this are a logistics system to bring fuel supplies to emergency power units and solutions for passing on information to crisis managers as well as to the population. These topics are worked on in the projects TankNotStrom (engl.: TankEmergencyPower)<sup>19</sup> and Katastrophenschutz-Leuchttürme (engl.: Disaster Protection Lighthouses),<sup>20</sup> funded by the German Ministry of Education and Research.

Solutions for a limited power supply on a household level are also being worked on.<sup>21</sup> Powered by small devices, mostly using regenerative energies, individuals can build up their own emergency supply and take precautions (BBK 2015a). Guidelines for emergency power supplies for authorities and companies are also available (BBK 2015b).

### 4. Response

The ability to respond in case of a major power outage depends strongly on the level of preparedness. Only structures and procedures that were established beforehand can be quickly used in a crisis. The effectiveness is validated by exercises and real-life events.

In 2004 the exercise scenario for the German cross-state (Laender) exercise in national crisis management (LÜKEX) was a power blackout in one of the German states.<sup>22</sup> The experiences from the exercise were compiled in the Crisis Handbook Electricity Blackout (Krisenhandbuch Stromausfall) (BBK, IM BW and KIT, 2010). This contains extensive information and detailed checklists on crisis management in cases of blackouts.

Actual power blackouts are rare events in Germany, where the annual power interruption per person ranks at approximately 15 to 20 minutes. However, there have been a few long-lasting blackouts caused by the snow storms in northern Germany in the winter of 1978/1979 and the snow storm in the Münster area in November 2005. The latter is a reference for much of the current emergency planning. Around 250,000 people (at first more, then less) were without power for several days. The situation was handled without much more than economic damage, due to the good cooperation of the involved emergency response teams and the close collaboration of different power companies. The situation was also less destructive than it might have been in a more densely populated area, since personal preparedness (food supplies, ovens) was comparatively high (BNetzA 2006).

### 5. Recovery

When a harmful event has taken place, people tend to learn from it. It is no coincidence that people are better-prepared for events that they have experienced before. This is valid also for electricity blackouts.

Smaller blackouts with several thousand affected citizens within one county or city take place more frequently than large events. The electricity supply is mainly restored within a few hours, but sometimes the disruption lasts for a day or longer. Although these events are only small, they challenge the local authorities, infrastructure operators, and disaster response teams. In cities that have experienced such blackouts, emergency power supplies are often strengthened in the aftermath.

The risk recovery phase is usually a window of opportunity for implementing additional protection measures. The stakeholders wish to avoid the same kind of damage in the

18 Some of the German states (Länder) as well as some counties or other administrative bodies have already done detailed work on the topic and published guidelines or analyses on the topic. Just two examples are:

Hessisches Ministerium des Innern und für Sport (HMdIS) (2013): *Rahmenempfehlungen zur Einsatzplanung des Brand- und Katastrophenschutzes bei flächendeckendem, langandauerndem Stromausfall*. Online available at <https://innen.hessen.de/sicherheit/katastrophenschutz/infothek/rahmenempfehlung-stromausfall-0>. (German only)

Regierungspräsidium Karlsruhe (2014): *Musternotfallplan Stromausfall. Handlungsempfehlungen zur Vorbereitung auf einen flächendeckenden und langanhaltenden Stromausfall*. Online available at [http://www.lfs-bw.de/meldungen/aktuelles/archiv/archiv2014/Documents/2014011\\_MNP\\_Stromausfall.pdf](http://www.lfs-bw.de/meldungen/aktuelles/archiv/archiv2014/Documents/2014011_MNP_Stromausfall.pdf). (German only)

19 <http://www.tanknotstrom.de/>

20 <http://www.kat-leuchtturm.de/>

21 [http://www.kat-leuchtturm.de/x\\_k2db4zhweo70Dzwo.html](http://www.kat-leuchtturm.de/x_k2db4zhweo70Dzwo.html)

22 [http://www.bbk.bund.de/DE/AufgabenundAusstattung/Krisenmanagement/Luekex/Vergangene\\_Uebungen/vergangene\\_uebungen\\_node.html](http://www.bbk.bund.de/DE/AufgabenundAusstattung/Krisenmanagement/Luekex/Vergangene_Uebungen/vergangene_uebungen_node.html)

future, so that destroyed infrastructure components are rebuilt in a less vulnerable way. Following the winter storm in the Münster area 2005 and the highly destructive storm Kyrrill in January 2007, the electricity network operators have worked together in an association and adjusted their criteria for building electrical towers. With their new Technical Rule they went beyond setting stricter standards for new towers to better resist storms and ice load. Under certain conditions even the existing towers need to be retrofitted to fulfill the criteria of the technical rule VDE-AR-N 4210-4, 2014.

## 6. Conclusion

The various examples provided, which are by no means complete, show that the issue of power blackout due to natural disasters is acknowledged as a serious issue to be addressed in Germany. Germany has a strictly federal system, which means that civil protection is largely composed of different volunteer organizations. Even without this special setting, however, the protection from electrical failures is a task that has to be performed by a multitude of different stakeholders. Authorities, private operators, and the public all have to work together to protect citizens effectively.

The examples also illustrate the wide variety of possible measures when it comes to protecting electricity networks and protecting citizens from blackouts. The different phases of risk and crisis management – prevention, preparedness, response, and recovery – pose different challenges. They also provide different opportunities for protection. If these are utilized well, then a good protection level can be reached.

## References

BBK, IM BW, KIT (2010): Krisenhandbuch Stromausfall Baden-Württemberg. Handbuch mit Planungshilfen. Bonn. Short Version available at [http://www.bbk.bund.de/SharedDocs/Downloads/BBK/DE/Publikationen/PublikationenKritis/Krisenhandbuch\\_Stromausfall\\_Kurzfasung\\_pdf.html](http://www.bbk.bund.de/SharedDocs/Downloads/BBK/DE/Publikationen/PublikationenKritis/Krisenhandbuch_Stromausfall_Kurzfasung_pdf.html). (German only)

BBK (2014): Stromausfall. Grundlagen und Methoden zur Reduzierung des Ausfallrisikos der Stromversorgung. Wissenschaftsforum 12. Online available at [http://www.bbk.bund.de/SharedDocs/Downloads/BBK/DE/Publikationen/Wissenschaftsforum/Bd12\\_Stromausfall.pdf?\\_\\_blob=publicationFile,p 61](http://www.bbk.bund.de/SharedDocs/Downloads/BBK/DE/Publikationen/Wissenschaftsforum/Bd12_Stromausfall.pdf?__blob=publicationFile,p 61). (German only)

BBK, UNU (2014): Assessing Vulnerability to Flood Events at a Community Level. Practical Experience in Civil Protection 4. Online available at [http://www.bbk.bund.de/SharedDocs/Downloads/BBK/EN/booklets\\_leaflets/Assessing\\_Vulnerability\\_to\\_Flood\\_Events.pdf?\\_\\_blob=publicationFile, pp 157-168](http://www.bbk.bund.de/SharedDocs/Downloads/BBK/EN/booklets_leaflets/Assessing_Vulnerability_to_Flood_Events.pdf?__blob=publicationFile, pp 157-168).

BBK (2015a): Stromausfall. Vorsorge und Selbsthilfe. Online available at [http://www.bbk.bund.de/SharedDocs/Downloads/BBK/DE/Publikationen/PublikationenKritis/Stromausfall\\_Vorsorge\\_u\\_Selbsthilfe.pdf?\\_\\_blob=publicationFile](http://www.bbk.bund.de/SharedDocs/Downloads/BBK/DE/Publikationen/PublikationenKritis/Stromausfall_Vorsorge_u_Selbsthilfe.pdf?__blob=publicationFile). (German only)

BBK (2015b): Notstromversorgung in Unternehmen und Behörden. Praxis im Bevölkerungsschutz 13. Online available at <http://www.bbk.bund.de/SharedDocs/Downloads/BBK/DE/Publikationen/>

[Praxis\\_Bevoelkerungsschutz/Band\\_13\\_Notstromversorgung.pdf?\\_\\_blob=publicationFile](#). (German only)

BMI (2009): National Strategy for Critical Infrastructure Protection (CIP Strategy). Online available at [http://www.bmi.bund.de/cae/servlet/contentblob/598732/publicationFile/34423/kritis\\_englisch.pdf](http://www.bmi.bund.de/cae/servlet/contentblob/598732/publicationFile/34423/kritis_englisch.pdf)

BMI (2011): Schutz Kritischer Infrastrukturen – Risiko- und Krisenmanagement. Leitfaden für Unternehmen und Behörden. Online available at [http://www.bmi.bund.de/SharedDocs/Downloads/DE/Broschueren/2008/Leitfaden\\_Schutz\\_kritischer\\_Infrastrukturen.pdf?\\_\\_blob=publicationFile](http://www.bmi.bund.de/SharedDocs/Downloads/DE/Broschueren/2008/Leitfaden_Schutz_kritischer_Infrastrukturen.pdf?__blob=publicationFile). (German only)

BNetzA (2006): Untersuchungsbericht über die Versorgungsstörungen im Netzgebiet des RWE im Münsterland vom 25.11.2005. Online available at [http://www.bundesnetzagentur.de/SharedDocs/Downloads/DE/Sachgebiete/Energie/Unternehmen\\_Institutionen/Versorgungssicherheit/Berichte\\_Fallanalysen/Bericht\\_12.pdf?\\_\\_blob=publicationFile&v=2](http://www.bundesnetzagentur.de/SharedDocs/Downloads/DE/Sachgebiete/Energie/Unternehmen_Institutionen/Versorgungssicherheit/Berichte_Fallanalysen/Bericht_12.pdf?__blob=publicationFile&v=2). (German only)

BSI (2014): UP KRITIS - Public-Private Partnership for Critical Infrastructure Protection. Basis and Goals. Bonn. Online available at [http://www.kritis.bund.de/SharedDocs/Downloads/Kritis/EN/UP%20KRITIS.pdf?\\_\\_blob=publicationFile](http://www.kritis.bund.de/SharedDocs/Downloads/Kritis/EN/UP%20KRITIS.pdf?__blob=publicationFile).

Deutscher Bundestag (2013): Unterrichtung durch die Bundesregierung. Bericht zur Risikoanalyse im Bevölkerungsschutz 2013 (Drucksache, 18/208). Online available at <http://dip21.bundestag.de/dip21/btd/18/002/1800208.pdf>. (German only)

Ibid., pp 155-176.

ISO.IEC 31010:2009 – Risk management – Risk assessment techniques.

Petermann T, Bradke H, Lüllmann A, Poetzsch M, Riehm U (2010). Gefährdung und Verletzbarkeit moderner Gesellschaften am Beispiel eines großräumigen und langandauernden Ausfalls der Stromversorgung. Endbericht zum TA-Projekt (Arbeitsbericht, Nr. 141). Online available at <http://www.tab-beim-bundestag.de/de/pdf/publikationen/berichte/TAB-Arbeitsbericht-ab141.pdf>. (German only)

Raumordnungsgesetz (ROG) §2 (2) Sentence 3, available at <https://dejure.org/gesetze/ROG>. (German only)

VDE-AR-N 4210-4 (2014): Anforderungen an die Zuverlässigkeit bestehender Stützpunkte von Freileitungen. Online available at <https://www.vde.com/de/fnn/arbeitsgebiete/seiten/n4210-4.aspx>.

## 3.2. GO15

Hubert Lemmens, Terry Boston,  
Alain Steven,  
GO15

### Introduction

With the continued population growth, economic development, and the shift towards a higher share of electric power in energy consumption, energy demand is expected to double in the next 15 years. Due to new technologies, the costs associated with energy interruptions will rise. In addition, blackouts have been seen not only as technical issues, but also as subject to strong political influence.

In the last decades, the most frequent causes of system disturbances have been: natural phenomena, communication and control system failure, design and application error, operator error, and primary equipment failure.

New environmental constraints affecting or delaying the building of traditional power plants and new transmission corridors have aggravated power system performance.

More recently, electricity in common with other physical and logistic networks has been subject to natural disasters and to threats from aggressors; all networks have vulnerabilities that are difficult to defend. See the report published by the Office of Technology Assessment of the U.S. Congress, "Physical Vulnerability of the Electric System to Natural Disasters and Sabotage." This report also documents the interruption costs, estimating them to be in the range from \$1 - \$5 /Kwh of disrupted service, depending on the length of outage, the types of customers affected, and the time of day.

Power system vulnerability has significantly increased in recent years for several reasons: dramatic increase in interregional bulk power transfers, leading power systems to operate closer to their limits; increase in transmission trunk bottlenecks; new environmental constraints leading to difficulties in building new transmission facilities and hydro plants (mainly with reservoirs); integration of renewable generation sources (RES) replacing traditional thermal generation. Europe today is facing the fundamental challenge of shifting from large-scale, centralized predictable power generation to a system in which generation capacity is becoming decentralized and intermittent.

Without a doubt, the electricity industry is being impacted immensely by the fundamental shift in the base load generation mix. For example, low gas prices and an abundant gas supply, combined with stringent environmental policies in the USA are driving the change from coal- to gas-based. The consequences are electricity generation far from load centers, increase in transmission trunk power flow, and new generating units with poor controls, all of which affect power system reliability and security.

In the last years, new issues have been affecting power system performance in a negative way. These has been an increase in natural disasters, cyber/internet attacks, and vandalism. It is important to note that all threats to security travel either through the power network itself or via communication and information systems. In terms of natural disasters: heat waves are hotter, heavy rain events are more frequent, and winter storms have increased in both frequency and intensity. These kinds of events are among the leading causes of large-scale power outages. The increasing occurrence of severe weather could lead to infrastructure breakdown with far-reaching consequences. In some countries, acts of vandalism motivated by theft are quite common, as when transmission line

cables are stolen or guyed cables cut off, thus occasioning faults on the transmission lines. A sharp increase in cyber attacks targeting the power industry, along with the proliferation of computing devices in the field to support smart grid initiatives, will require utilities to rethink cyber security.

System operators are facing unprecedented challenges in the threat levels confronting their enterprises: terrorists, hostile states, criminality, and extreme weather conditions. Although, to date physical and/or cyber attacks have not led to severe blackouts, several measures must to be adopted in the face of increasingly sophisticated and frequent attacks. We need to understand and accept this reality and to adopt countermeasures to ensure power system security.

This report will focus on the problems caused by adverse weather conditions and will propose actions to minimize their impact. Of course, the proposed remedial actions can also help power systems to face multiple contingencies from different causes or origins. Power system restoration can take from hours to days and even weeks for distribution grids, depending on the severity of the blackout and the physical damage to power system infrastructure. The societal reaction increases the longer the total restoration time takes.

## Understanding challenges

It is difficult to imagine modern society without a power grid that provides electricity in a reliable, cost-effective, efficient, and timely manner. The trends are towards increasing needs for more and more energy. This infrastructure will thus face a number of new challenges.

The challenges we are addressing are familiar to everyone involved in grid modernization: cyber security, the integration of renewable energy sources, gaps in standards, harmonization of global standards, consumer engagement and transactive energy, to name a few.

More recently and assuming that threats continue increasing in the short run, power system security is likely to degrade. Possible impacts to nuclear generation also cause some uncertainty regarding the future of the industry.

Clearly, society expects increased reliability and reduced restoration time. Thus, pressures have increased considerably for utilities. Under the critical eye of both regulators and consumers, we must ask: are utilities currently better prepared to face extreme weather than they were before?

For example, Superstorm Sandy interrupted power to close to two million customers of the PSE&G (Public Service Enterprise Group of New Jersey), who went a combined 164 million hours without electricity. Waters from Hurricane Irene and Sandy damaged 29 substations.

### Basic structure of the electric system.

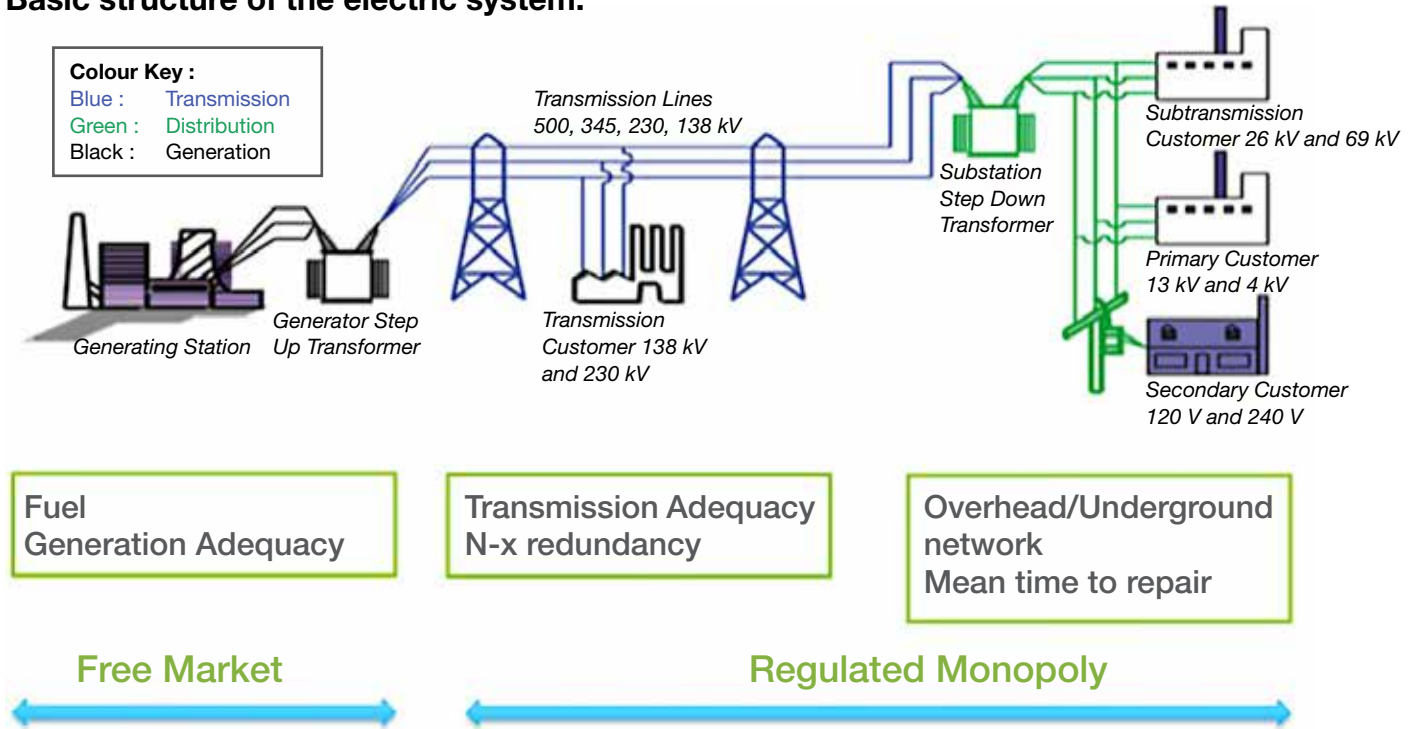

Figure 42: Basic structure of the electric system

Source: US DOE, complemented by the authors

Local US leaders clearly remember what occurred after Hurricane Irene and Superstorm Sandy. They understand the costs imposed by extended outages and expect to see measures to protect against the next storm.

The number of record-breaking storms since 2011 especially in the northeast of the USA has increased attention on utilities and their ability to handle emergency response. As billions of US dollars have been used to battle power outages and energy supply shortages because of the 2015-16 low temperatures, consumers are wondering what the weather might bring next and if their local power company will be prepared. In Europe, Maros Sefcovic, Vice President of the European Commission and in charge of energy union in the 28-nation EU bloc, announced on 1 April 2015 that the European Commission plans to introduce stress tests for the power sector in 2016 along the lines of those carried out for the EU gas sector. It is, therefore key to understand and accept this new reality if cost-effective countermeasures are to be adopted to ensure power system security.

### Long-term security of supply

In general, and at the level of an entire power system, long-term security of supply depends on: secure access to fuels; generation adequacy on a regional basis, taking into account reserves for maintenance and unplanned outages; transmission adequacy; and the transmission capacity available within a given region to accommodate power transfers. Resistance to the physical threats and redundancy of infrastructure

are key elements for resilience. Security of supply also depends on real time observability and controllability resources (ENTSO-E 2012).

While generation investments are made at the initiative of market players and mainly driven by economic objectives, transmission investments are planned and realized under a regulated regime and are subject to reliability criteria (ENTSO-E Ten Year Network Development Plan). Therefore, the transmission grid is planned with redundancy (N-1 criterion); however, common mode failures are in general not covered. The (N-2) criterion is adopted in specific cases only.

### Short-term reliability of the power system

When we think about short-term reliability of the power system, we have to consider different threats:

- Failures in the distribution grids which in general are not redundant by design, meaning that a single failure will be experienced by the consumer as a power interruption
- “Excursions” from planning criteria: events that for economic reasons cannot be taken into account in grid planning criteria. Examples are multiple simultaneous failures
- Delay in transmission corridor chronograms.
- Asset aging: the actual performance of an asset, compared to its original design requirements.
- Human errors caused, for example, by unreliable information, flawed reasoning and decision making, or faulty execution of an intervention in the power system.

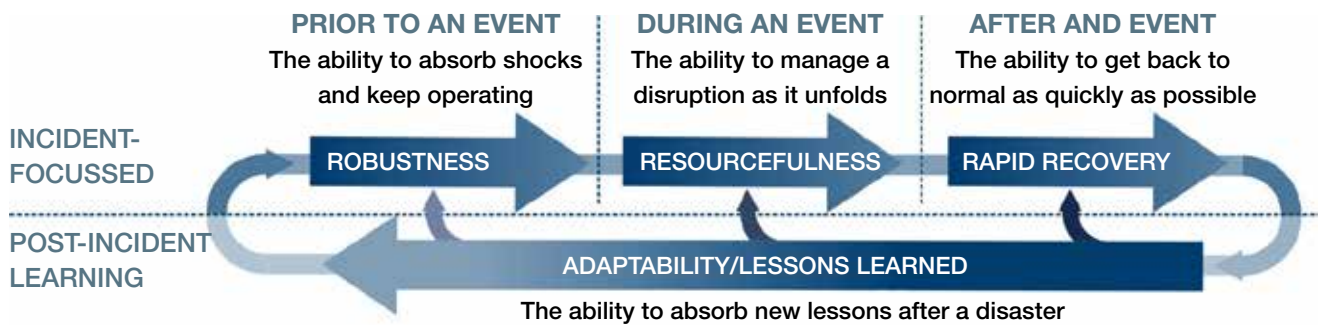

Figure 43: Resilience concept

Source: PJM

- Forecast errors for renewable energy resources
- Combination of the above-mentioned risks

On top of these mostly internal threats, some additional external threats are emerging: severe weather events, and cyber attacks and terrorist attacks against grid infrastructure. These are nowadays considered as the most serious and difficult in terms of managing risks to a secure power supply.

## Metrics

To measure the quality of power supply, several critical performance indicators (CPIs) have been identified. Some of the most commonly used are listed here:

- Number of affected consumers
- Affected area
- Average load restoration time
- Average Interruption Time (AIT): the time a customer would not be supplied if all power not been delivered due to power failures during a year were to be equally spread among all consumers
- System average interruption duration index (SAIDI): the time a customer would not be supplied in a given year if interruptions were equally spread among all consumers

SAIDI is a measure for the frequency and duration of the interruptions, while AIT places the emphasis on the impact of the power failures.

## Improving resilience

Figure 43 is used to describe members' response to severe events and GO15 support to its members in improving grid resilience. It includes several blocks, such as prior to an event, during an event, and after an event.

**Prior to an event:** the cost versus security dilemma or cost/benefit trade-off appear. There is a need to increase the resilience of transmission equipment so it can remain reliable under a wider range of ambient conditions. The capital cost

of such a move is likely to be very high. In addition, as we are dealing here with relatively rare conditions, it would be very difficult to justify large-scale projects on this basis. However, limited-scale projects for critical corridors could well be justified. A generic model was developed by GO15 members to enable experience exchange and benchmarking at the level of design criteria. However, no common standards could be proposed due to the great differences in boundary conditions of the different power systems.

**During an event:** operation of the power system in a more secure mode than normal when such severe natural phenomena are forecast. If the risk is high, then such measures can usually be justified. If the system becomes unstable, power system operators trigger "*Defense Plan*" to return to stable state; the main measures are load shedding, generation dropping, and islanding.

After an event: after stabilization (could be during blackout): activation of "*Restoration plan*": this is a systematic approach for repowering lost load and reducing duration of impact. In the case of severe infrastructure damage, restoration can take days to weeks –deployment of the disaster recovery plan, coordination of operational teams, external contractors, consultation with public authorities, priority setting, communication. GO15 provides two supporting tools: a *crisis communication network and communication protocol*, helping members to understand what is happening in another member's system and a *framework for mutual assistance*, which enables members to provide each other with emergency help and relief in case serious infrastructure damage has occurred.

**Post-incident learning:** a database with case studies on severe power system failure is available for members to enable them to learn from other incidents.

## Framework for mutual assistance

By sharing operational experiences and best practices, the capability of Power Grid Operators around the world to re-

spond quickly to exceptional situations is greatly enhanced. In cases of extensive damage to the power grid assets, restoration of the service is accelerated by obtaining spare equipment and resources from neighboring operators. In this context, the GO15 members have developed a framework for Mutual Assistance. The aim of the framework is to speed up restoration after a major power disturbance, on the one hand by sharing experiences, and on the other hand by facilitating arrangements among the members for access to spare parts and workforces.

The framework includes a signed protocol which defines pre-agreed terms for such assistance, a library of relevant reports documenting how previous incidents were handled, and a mapping guide that helps members in need of assistance to quickly access subject matter experts who can be consulted to address specific types of incidents.

The protocol of mutual assistance expresses the will of GO15 members to collaborate, and encompasses a template for contractual agreement. This template can avoid lengthy negotiations about terms and conditions when there is a request for assistance. The library is composed of contributions from the members featuring reports from past incidents in the GO15 members' networks and the way they were handled, including root cause analysis and recommendations. Additionally, general interest publications about threats to secure operation of the electricity networks are shared.

The mapping guide is a practical tool that allows experts from the members and a list of available spare parts to be indexed to any to subject matters. It thus helps members in their search for help to identify the right companies and the right persons within the companies, member of GO15.

It is well known that in case of severe crisis, communication is of utmost importance. Therefore, the framework constitutes a Crisis Communication Network. The members of GO15 have agreed on guidelines for information exchange with the aim of facilitating support actions and promoting efficient communication among members if a major event occurs.

### 3.3. Insurance industry

**Brigitte Balthasar,**  
**Torolf Hamm and Marc Lehmann**  
 Willis Towers Watson and Willis Re

Energy infrastructure, particularly the electric power grid, is one of the critical lifeline infrastructures on which many other types of critical infrastructure depend. As we have

seen over the years, low frequency, high impact events such as natural hazards can cause significant property damage and business interruption to critical infrastructure. A major event like an earthquake, windstorm, or flood ultimately impact the ability to provide and maintain vital lifeline supplies to the wider population. The destruction of this infrastructure can cause a significant impact to national security and economy. Such events do not occur just in highly exposed regions around the world. We have witnessed the damage and disruption that recent storm events such as Desmond (December 2015) and Imogen/Ruzica (February 2016) have caused to various parts of the UK and EU knocking out power lines and flooding entire substations and resulting in the prolonged loss of power to many households and businesses.

Transferring risk to insurance is part of financial risk management. Insurance is a mechanism for sharing risks over time, a large group, and geographical areas; however, it does not mitigate or reduce potential disaster consequences or occurrence probability. Yet, within the insurance and reinsurance industry there is enormous knowledge and expertise in identifying, analyzing, and modeling risks that can be accessed through insurance transactions. This enables and empowers the insured to better understand the probable risks and help develop further risk mitigation strategies and integrative risk management approaches. With respect to electricity networks one needs to keep in mind that infrastructure owners are not directly exposed to the full costs borne by society due to infrastructure failure in the event of a natural catastrophe. Thus, the losses incurred by individuals and companies due to power outage can be much larger than the cost to the electrical utility of repairing the damage.

This article offers some possible pre-event risk management concepts and methodologies to help electricity networks identify exposures, quantify expected losses or likely downtimes, and consider good practice risk mitigation solutions. It will briefly discuss some typically observed vulnerabilities of electrical power network systems to different perils, comment on our experience in the assessment of these types of assets regarding natural hazards, and present tools and risk assessment techniques employed to assess the general resilience of power distribution and transmission systems. This section is rounded up by some insights on Superstorm Sandy. Given the evolution of risk, an outlook on emerging risks will be provided followed by some concluding comments.

Electricity is an essential resource for many critical services (e.g., water, gas, communications, internet etc.), and other infrastructure systems depend on its continuity for their smooth functioning. At the same time electricity power networks have continued to develop into large and highly complex technical systems with a greater geographical spread, which means that exposure to natural hazards is increasing. The very occurrence of natural disasters and their impact

on electricity power networks has been the focus of many countries around the world, as has been the need to enhance the resilience of these infrastructure systems, particularly in light of evolving trends such as climate change. Resilience depends on equipment, building codes, and technology, but even more so on the organization, mitigation, and standardized emergency preparedness of well-structured electricity companies.

According to a report (Cabinet Office 2011), the UK energy sector under the direction of the Energy Networks Association (ENA) produced an Engineering Technical Report on Resilience of Flooding of Grid and Primary Substations (ETR 138). The report provides a risk-based approach to flooding as well as methods to improve the resilience of services where this was technically feasible and economically viable. The electricity transmission and distribution industry has set out target levels (standards) of resilience for different assets within their sector, which includes a risk-based target of a 1 in 1000 (0.1%) annual probability flood for the highest priority assets within their critical national infrastructure. Other measures to improve resilience include the capacity to reconnect or provide an alternative energy supply to consumers. This model of cooperation in the development of standards is being rolled out further to evaluate other hazards in the energy sector.

## Asset and operational vulnerabilities of electricity networks

Natural hazards that have the potential to cause extended blackouts include earthquakes, (extra) tropical storms, tornados, flooding, and severe thunderstorms. Each type of peril can affect power systems in a different way. Earthquakes, for example, can damage all types of power system equipment, and are the most likely to cause power interruptions lasting more than a few days. Other perils such as windstorms mostly affect the overhead transmission and local distribution (T&D) lines, whereas widespread flooding can impact lower level electrical generating equipment, resulting in extended business interruption losses. Tornados and severe thunderstorms can also affect transmission and distribution lines through lightning strikes and wind damage, coupled with falling trees and other wind-borne debris capable of pulling down complete lines. Winter storms can create ice buildup on power lines resulting in increased wind exposure and weight on the high voltage cables.

From an earthquake perspective it is worth noting that the increase in transmission voltage over the years has resulted in larger substation equipment, the size and weight of which makes it more vulnerable to lateral seismic loading. The increased exposure to damage is caused by two principal factors: i) a drop in the frequencies of vibration into a lower and more severe region of the characteristic seismic frequency

range, which produces an amplification of the seismic forces in the equipment (resonance effect); and ii) inherent structural deficiencies, notably the brittle nature and low-energy dissipation properties of electrical insulating material such as porcelain equipment used, for example, at 230 and 500kV substations. Heavy, unanchored circuit breakers and transformers can also be susceptible to sliding and overturning damage as a result of strong ground motions. While the transmission lines, towers, and poles are generally less susceptible to ground shaking due to their flexibility, earthquakes can still cause transmission outages when tower foundations are subject to earth slippage. Detailed soil analyses, adequate foundation design, and periodic inspection of existing foundations are therefore essential at the outset and during the lifespan of the electrical network systems.

The variety of impacts can be attributed to the fact that generation and transmission systems consist of large, clustered assets in generation facilities and in substations, whereas distribution assets are spread over wide geographical areas. Overall, it heavily depends on the peril as well as risk location, which risk mitigation measures and risk management structures need to be put in place to protect the electricity network according to asset and operational vulnerabilities.

## Managing natural hazards

As part of one of the world's leading risk management and insurance intermediaries the Strategic Risk Consulting (SRC) team at Willis Towers Watson adopts a wide range of catastrophe risk consulting services to help utility companies better identify and quantify their exposure to natural hazard risks for a range of return periods and to assist in making more informed decisions to support their operational risk management, insurance purchasing, and mitigation requirements.

The methodology has been set out to address the questions we are hearing from our clients. For Electricity Networks, for example, these can include:

What hazards are our operations exposed to on a local, regional, or global basis?

What are the potential material damages and disruptions we may face due to a major natural hazard?

How do these compare with our current risk management strategies, resilience, and recovery plans?

Can more than one key facility or multiple parts of the network be affected by the same event?

What risk mitigation options can we consider to reduce our risk exposure?



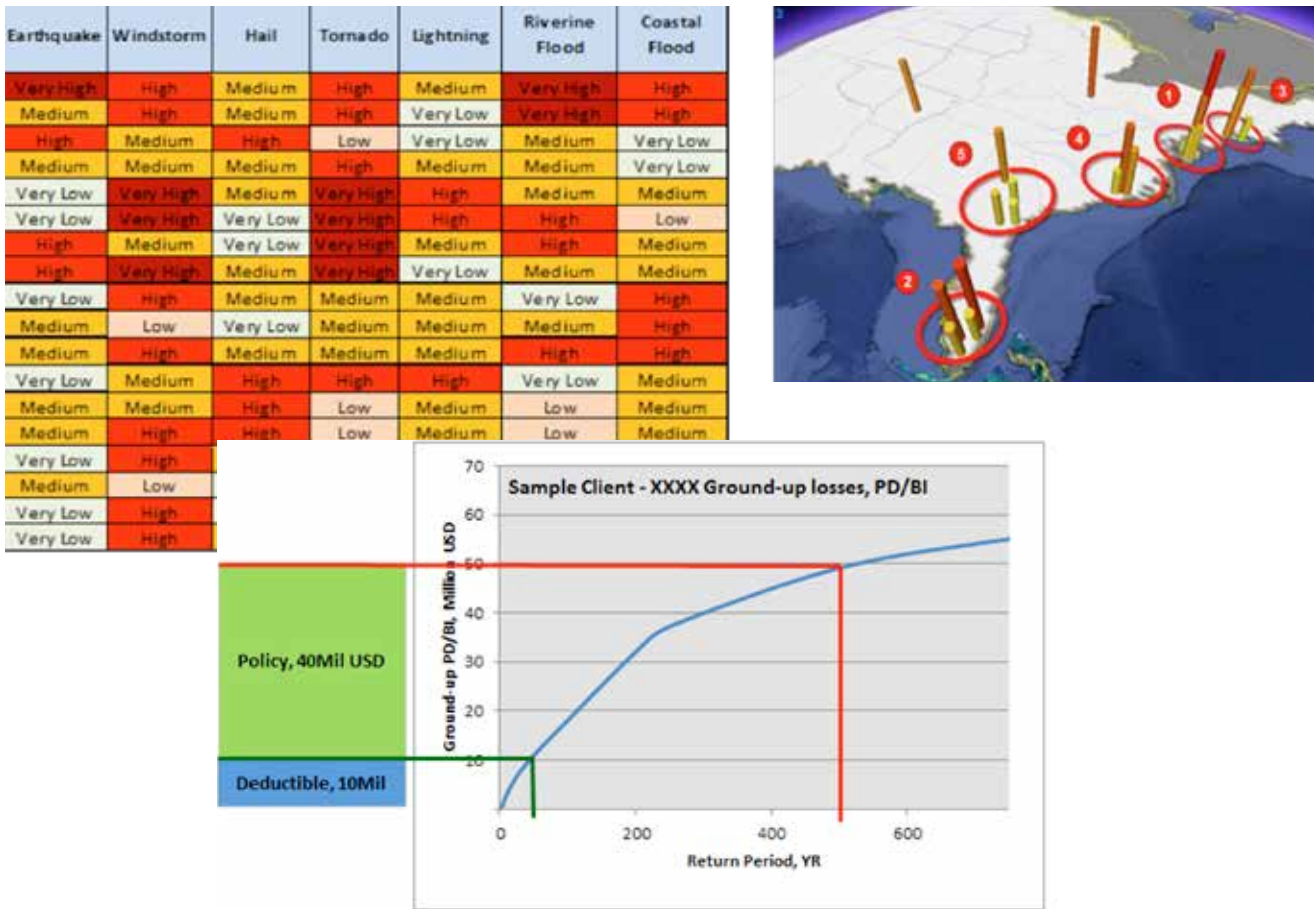

Figure 44. Sample Analysis Outputs

Source: Authors

Through this we adopt a comprehensive Natural Catastrophe Risk Management framework using the following top-down approach to help identify, evaluate and manage company-wide risks from natural perils:

Detailed review of a network’s natural hazard exposures on a global, regional, and single- site basis to help shape their strategy for managing natural catastrophe risks to their business.

Natural catastrophe modeling to quantify the expected losses and likely downtimes of the power network assets and assess which specific components are driving the risks by peril and region.

CAT Risk Engineering Assessments and Site Surveys for individual facilities of high value and strategic importance. Detailed estimates of the expected material damages and downtime as a result of a major natural event. Provision of recommendations to help reduce the risk exposure and improve business continuity at the facility.

The exposure and reliability of electricity networks under the action of natural hazard events can be assessed using a combination of geospatial mapping and probabilistic modeling

techniques to help evaluate and quantify the risks within the system. Geospatial mapping based on accurate location data can pinpoint assets and represent them in a clear visual manner to identify the components of the network that are at higher risk than others. In turn, this can help organizations to shape an appropriate strategy to manage these risks.

Below are some sample exhibits from this type of analysis. The image on the left side shows a “heatmap” or hazard matrix where we can evaluate which sites are exposed to which type of hazards and to what degree (red representing “Very High” hazard, green “Very Low”). To the right tools, such as Google Earth can be used to geospatially visualize the locations, their relative values (height of the bars) and identify possible clusters. At the bottom we show a sample catastrophe modeling graphic that represents a loss exceedance curve mapped against a sample insurance program, often used to assess if suitable insurance cover is in place to protect the assets against natural perils.

Quantitative catastrophe modeling can then capture the impact of a wide range of possible natural hazard scenarios such as earthquakes or windstorms on a system, and in particular those lower frequency higher impact (or extreme) events that

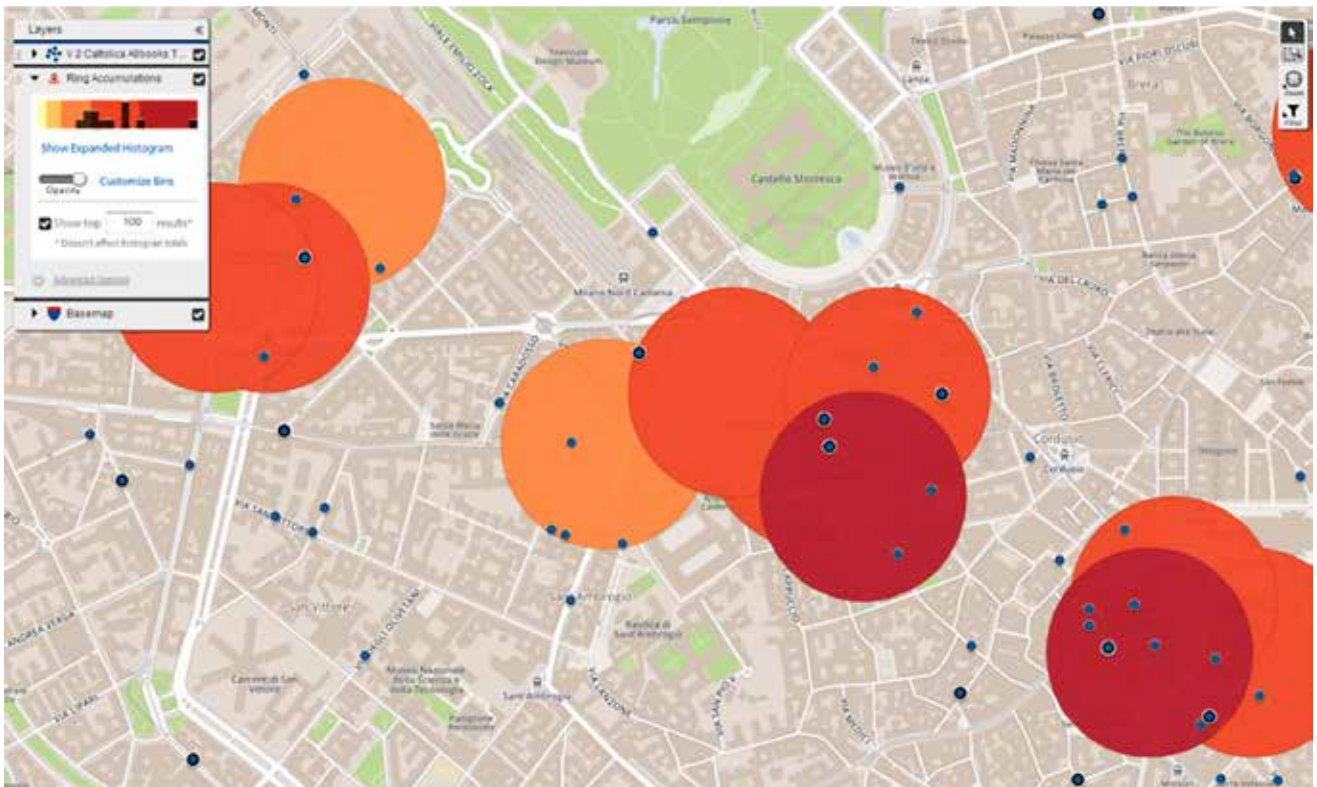

Figure 45. Accumulation analysis for regulatory modeling or conflagration analysis for terrorism risk

Source: Authors

would have the greatest impact on a power network. These models can also take into account the type of construction, age, and height of key assets to simulate the vulnerabilities to a given hazard. The outputs would typically comprise loss estimations for material damages and operational disruption or downtime, helping network operators focus their attention on where potential upgrades or additional redundancy may be required. Moreover, the modeling outputs support the decision making with respect to risk transfer and mitigation.

To assist clients, Willis Re has developed its own view of catastrophe risk for all major perils and territories globally. These models are complex risk quantification tools that are based on extensive scientific analysis. Despite this, there have been unexpected shocks when major loss events have occurred. Willis Re seeks a full understanding of what is and is not captured in these models and how to consider the complexities and uncertainties in catastrophe risk modeling. This enables our clients to more accurately understand, communicate, and efficiently mitigate their own risk.

To maintain and continuously enhance this view, the specialist teams work in close conjunction with the extensive resources of the Willis Research Network.<sup>23</sup> Given the specific



Figure 46. Identifying areas of peak exposure

Source: Authors

locations and exposure of electricity networks and power suppliers, one needs to work through the range of models and complex scientific views to establish if their view of risk is adequate. The geospatial visualization combined with catastrophe modeling within tools such as SpatialKey opens the world of effectively managing exposure accumulation and profitability, running location-based scenario analyses, as well as real-time monitoring and post-event reporting.

## CAT Risk Engineering Assessments

For individual, high value, and strategic level facilities such as a major substation or hydro power facility a detailed bespoke approach may prove to be more beneficial. This assessment would typically involve a detailed single site assessment

<sup>23</sup> The Willis Research Network is the world's largest insurance related network of academic institutions. It operates across the full spectrum of risk from natural catastrophe, to legal liability, financial and security issues linked across driving themes: Resilience, Security & Sustainable Growth; Managing Extremes; Insurance & Risk Management and Mastering the Modelled World.

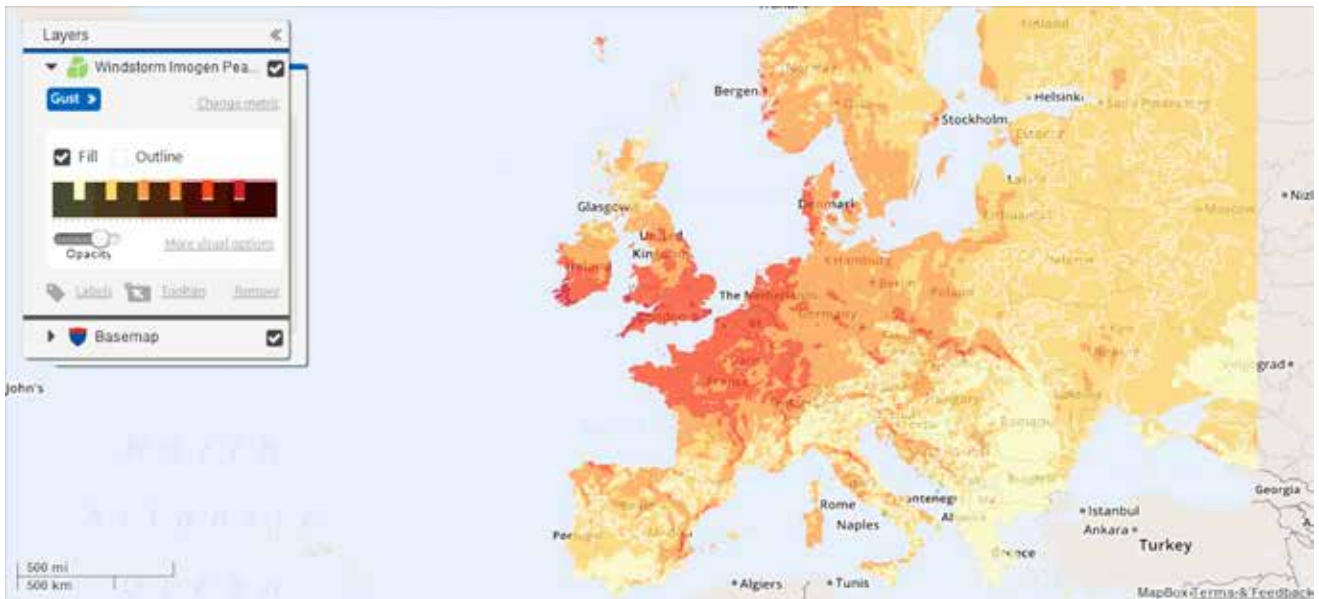

Figure 47. Developing a bespoke realistic disaster scenarios or post event calculations

Source: Authors



Figure 48. CAT risk engineering survey and PML assessment

Source: Authors

and/or physical site inspection by a specialist natural hazard engineer to assess in situ vulnerabilities and gain an understanding of likely failure modes, the associated loss potential (PML), and methods to reduce the risk exposures. From an earthquake perspective, the focus may be more on checking whether suitable anchorage and lateral restraint methods are in place for critical equipment such as transformers and generators, whereas for flood it can focus on the ingress routes of water into a facility and the elevation of susceptible assets such as electrical switchgear and control cabinets.

### Case study, Superstorm Sandy

In addition to the natural catastrophe risk assessment and modeling, academic research is another key to quantifying and understanding risk. Hence, close cooperation between the insurance industry and research ensures that the view of risk is maintained and at the highest standard. Below, a summary of post-event report and findings on Superstorm Sandy as at 6 November 2012 are described where members of

Willis Re's Catastrophe Management Services conducted post-event field assessments and Willis Research Network scientist Dr. Michael Kunz and his colleagues at the Center for Disaster Management and Risk Reduction Technology, Karlsruhe Institute of Technology, Germany, studied the direct and indirect impact of Sandy on business. This publicly available study helps to better understand electric utility behavior in the case of a catastrophic event and to draw conclusions on societal and economic implications.

Hurricane Sandy was a storm system with special meteorological characteristics and caused widespread damage from the Caribbean to the U.S. East Coast. At the U.S. coast, especially in New York, New Jersey, and Pennsylvania, Sandy resulted in a relatively high death toll compared to historic events. Critical infrastructure failures (electricity, transportation) are expected to lead to a high amount of indirect damages. The impact of Sandy on the longer term and the indirect losses are difficult to estimate due to the complex interrelations between socioeconomic and technical systems.

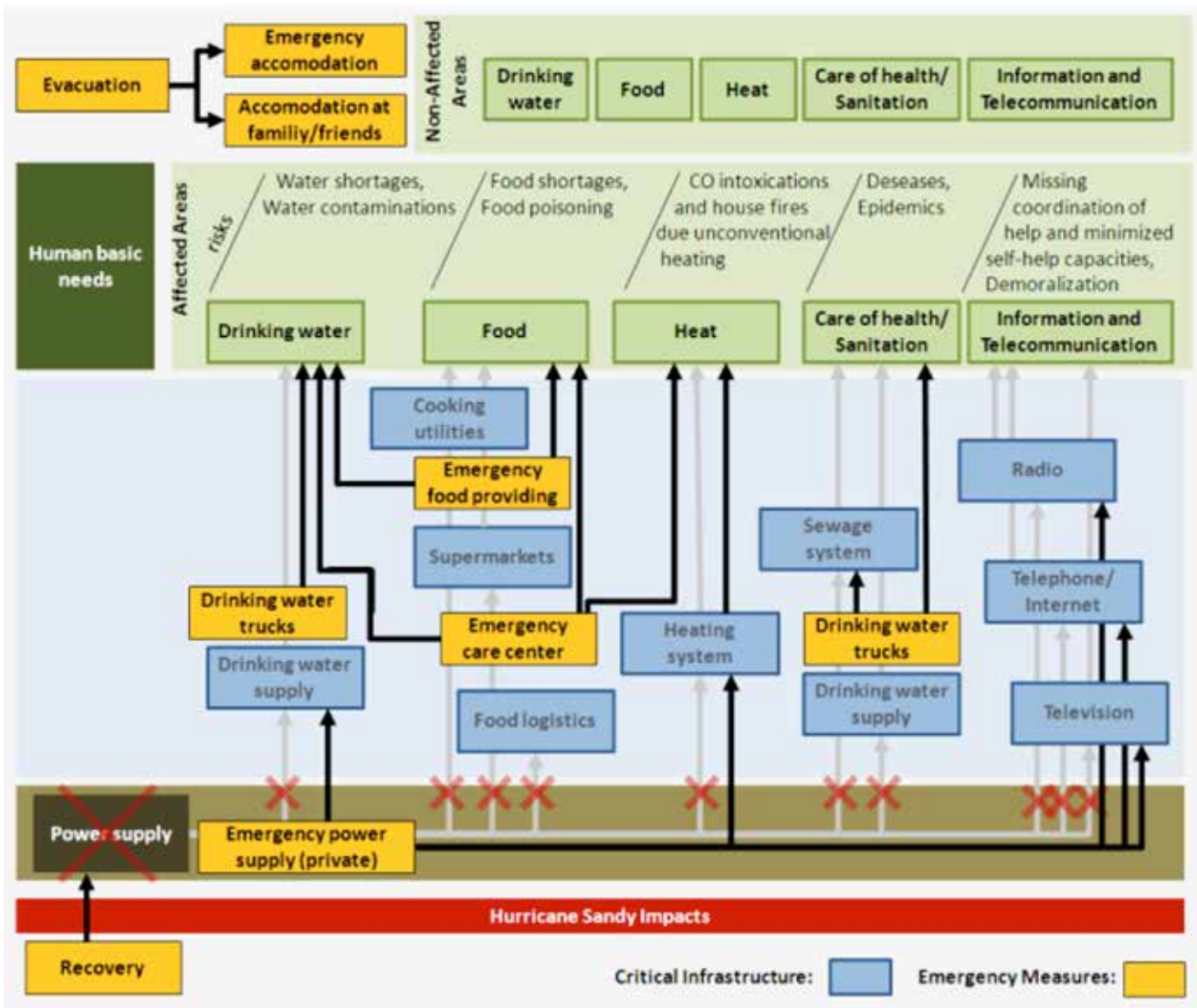

Figure 49. Very soft casual map/flow chart to capture main effects of extended power outages for human basic needs and possible emergency measures to avoid further risks.

Source: CEDIM

In most of the regions affected by Hurricane Sandy where the electricity broke down, the power supply was successfully restored after multiple blackouts. Power outages were reported on Monday 29 October and Tuesday 30 October in 14 north-eastern states, leaving an estimated 8.7million customers (approx. 2.51 people per residential customer) without power. A week after the storm, on Monday 5 November, around 1.3 million people were still affected by the outage. The storm stressed both the power utilities in their restoration schedules and the people living in the regions without power.

The (direct and indirect) costs of the blackout caused by Sandy can be roughly estimated by comparison with similar past events (e.g., 2003 northeast blackout of about \$6.3 billion, 2005 one-day blackout estimates of \$5.6 billion – calculation based on GDP per person and the number of people affected). Using a similar approach, the costs for the power outage following Sandy would be approximately \$2.6 billion

for the first day, and \$14.4 billion for ten days of blackout (using a GDP<sup>24</sup> per capita per day of \$132.72 and a linear recovery function from 20 million people affected on Monday, 29 October to 2 million on Wednesday 7 November). This linear function correlates well to the number of people reported without power. However, it overestimates towards the end of the ten-day estimate.

Overall, it was observed that Sandy caused extensive structural damage to buildings and structures from storm surge and related flooding in the surveyed areas. Building damage due to storm surge ranged from moderate to complete collapse. In general, the direct damage to buildings due to the wind component of the storm was none to minor. However, significant and widespread damage to structures was observed due to tree fall and other flying debris.

<sup>24</sup> It should be noted that this value of GDP is a U.S. country average, with the GDP per capita being around 1.3 times greater on the East Coast on average than the U.S. average.

## Contingency and emergency response planning

In addition to identifying and quantifying potential risks from natural hazards, the other requirement to ensure the resilience of a network is to put in place robust plans for both contingency and emergency response following a major event. Depending on the expected peril the requirements and procedures will be different for handling power flow instability after major disasters and ensuring that operators are trained to implement these contingency plans. Willis Towers Watson advises their clients regularly on good practice planning procedures aimed at complementing existing measures already put in place by the network operators.

## Outlook on emerging risks in the energy sector

The list of emerging risks covers the kind of perils that keep risk managers up at night: cyber risk, oil price volatility, the changing demands of today's workforce, corruption, terrorism, the over-confidence corporations have in the ability of their entity to withstand a negative event, and more. While the energy sector has been affected by natural disaster risk over centuries, there are new, emerging risks that threaten the operation and resilience of critical infrastructure. Given the uncertain and unknown forms, there is a challenge in understanding, analyzing, and quantifying such emerging risks; consequently, it is difficult to find appropriate management tools such as insurance products for those risks. However, as the market evolves, different types of insurance solutions are developed to account for the high degree of uncertainty and to open the option to share such risk. Moreover, within the world of catastrophe models new platforms and models are also being developed, for example, to quantify and assess terrorism and cyber risk.

In addition to the mentioned risk, space weather events are another threat to the electricity networks. When the sun's surface ties itself in a knot, the results can be unimaginably powerful and blindingly beautiful. At the end of February 2014 space weather enthusiasts were spoiled by the biggest solar flare, and associated coronal mass ejection (CME), of the year – classified as an X4.9. X-class denotes the most intense flares, and these are often followed by long-lasting solar radiation storms. The scale is based on a multiplication scheme: X2 is twice as intense as X1; X3 is three times the intensity, and so forth. The main impact of this event was a mesmerizing display of Aurora Borealis. But solar flares can have a much more damaging impact on earth by disrupting communications technology, like satellites, and trashing electrical infrastructure. When solar storms strike the earth, electrical surges can damage power grids by blowing transformers and can also create interference with high-frequency radio communications and GPS systems. The wide regional

or even global impacts solar storms can have on infrastructure and the consequent cost for repair and recovery, not to mention loss due to business interruption, require attention and forewarning.

To this end, space weather desks around the world are monitoring the sun and are able to give alerts for when an event is on the way, hopefully helping to mitigate damages or loss. Even though we are more vulnerable than ever due to increased exposure and reliance on susceptible infrastructure, we are also more prepared than ever to mitigate geomagnetic disaster. Data and models are available through NASA's Heliophysics Division (among other sources) for academic, civil, and industrial use, allowing us to learn more about this beautiful yet potentially disruptive risk.

## Insurance mechanisms: A useful tool to mitigate risk and absorb losses from disaster

The key tasks and core of the insurance industry is understanding and identifying risk – the threefold of hazard, vulnerability, and exposure. To manage insurance products and financial risks, it is necessary to estimate occurrence rates of events and associated economic damages with a certain level of reliability. Within the insurance business, certain technical and actuarial expertise has been developed with respect to the abundance of historic data in order to provide risk assessment and risk allocation mechanisms that are not only used by households and business to absorb losses from disasters, but equally valid for governments. This knowledge can also help to adapt and become more resilient to catastrophes through better understanding of the risk, providing economic incentives to certain behaviors that can reduce risk, contributing to data collection to assess risk, promoting risk awareness and possibly improving (re-)construction methods (or codes) and regulation.

## References

'A Guide to improving the resilience of critical infrastructure and essential services', Cabinet Office Oct 2011.

Knutson et. al., "Tropical Cyclones and Climate Change," NATURE GEOSCIENCE Vol.3, p. 157-163 (2010)

"Global Climate Projections," in CLIMATE CHANGE 2007: THE PHYSICAL SCIENCE BASIS. Contribution of Working Group I to the Fourth Assessment Report of the Intergovernmental Panel on Climate Change (2007).

"State of the Science Fact Sheet: Atlantic Hurricanes, Climate Variability, and Global Warming," National Oceanic and Atmospheric Association, May 2012.

Michael Kunz et. al., CEDIM FDA-Report on Hurricane Sandy 22-30 October 2012, 2ndReport

## 3.4. Energy security: International organizations

**Kanat Botbaev,  
Iryna De Meyer**  
Energy Charter Secretariat

### Introduction

Energy is a backbone of the economy. The energy sector is critical to other sectors such as transportation, health, businesses, and households. The risk of natural disasters such as floods, droughts, earthquakes, tsunami, as well as intentional and unintentional human actions, make the “critical infrastructure” of energy extremely vulnerable. Disruption or damage to energy networks, especially in the complex and interconnected modern world, can affect millions of people, causing loss of life, multiple environmental impacts, and a cascade of interlinked economic losses.

The importance of protecting energy infrastructure cannot be underestimated. Recent examples of accidents caused by natural disasters and human actions in the energy sector clearly indicate that their scale and long-term consequences go far beyond national borders. Earthquakes and related tsunami, as well as climate-related disasters such as hurricanes, floods, landslides, or hail storms, mainly result in serious physical damage to the critical infrastructure, making it almost impossible for a single country to cope. The failure of energy networks often becomes a transboundary issue; therefore, any effort in this area needs to be of an international nature. Taking into account the current state of energy interdependence and interconnection, the biggest challenge to recover and restore requires coordinated efforts by the international community.

Today, maintaining the operation of the interconnected energy system is a challenge in itself, even if a major disaster does not place. As an example, the extreme weather conditions of February 2012 in continental Europe revealed other threats to energy networks. The growing share of intermittent energy sources throughout the European Union creates significant challenges for the transmission system operators of the interconnected systems. These risks, associated with the large-scale integration of renewables along with physical risks from natural and man-made disasters, impose major threats to the security of the energy supply, which has become a concern worldwide.

The Energy Charter, a multilateral organization promoting energy security and international cooperation, is unique in terms of its membership, which includes energy-producing, transit, and energy-consuming countries. The Energy Char-

ter promotes international cooperation in the energy field. The Charter framework covers the EU and its member states, countries of Central and Eastern Europe, Central Asia and the Caucasus, as well as Japan, Australia, Mongolia, and observer countries in African and American continents.

The legal framework of the Energy Charter provides for various instruments to sustain energy supply, including, inter alia, preventive diplomacy measures and mitigation of energy-related risks by means of the Model Energy Charter Early Warning Mechanism (the EWM).

### Energy Charter Early Warning Mechanism<sup>25</sup>

The Model Energy Charter Early Warning Mechanism was developed during the Russia- Ukraine gas dispute in 2014, but is designed to address emergency situations in any type of energy sector, including electricity. Hence, according to the Model Energy Charter Early Warning Mechanism, “Emergency situation” is a situation with a significant disruption or physical interruption of supply of electricity, natural gas, and oil within the Energy Charter constituency with cross border significance.<sup>26</sup>

According to Art. 2.1 of the Model Energy Charter Early Warning Mechanism, its objective “is to provide for a non-binding framework aimed at preventing and overcoming emergency situations in the energy sector related to the transit and supply of electricity, natural gas, oil and oil products through cross-border grids and pipelines.”

The methodology of the Model Energy Charter EWM includes “exchange of information and response to requests for information, consultations, confirmation of information and monitoring, risk evaluation and recommendations for action in view of an emergency situation or the threat of an emergency situation” (Art.2.2).

The mechanism presents three levels. The mechanism may be initiated by any signatory of the 1991 Energy Charter or the 2015 International Energy Charter in case of an emergency situation or the threat of an emergency situation by notification to the Secretary General (Art. 4.1). The notification should include relevant information, for example, a description of the situation, names of other parties that may be involved or affected, and any information requested from those. The notifying party and other Parties Involved or affected by an emergency situation are called the “Parties Involved” (Art. 4.3). Parties involved can assign their

25 See U. Rusnák; I. De Meyer “The Energy Charter Early Warning Mechanism: 2014 Russia-Ukraine-EU Transit Issues” OGEL 6 (2015), [www.ogel.org](http://www.ogel.org), URL: [www.ogel.org/article.asp?key=3598](http://www.ogel.org/article.asp?key=3598).

26 The text of the Model Energy Charter Early Warning Mechanism is available at <http://www.energycharter.org/fileadmin/DocumentsMedia/CCDECS/CCDEC201414.pdf>.

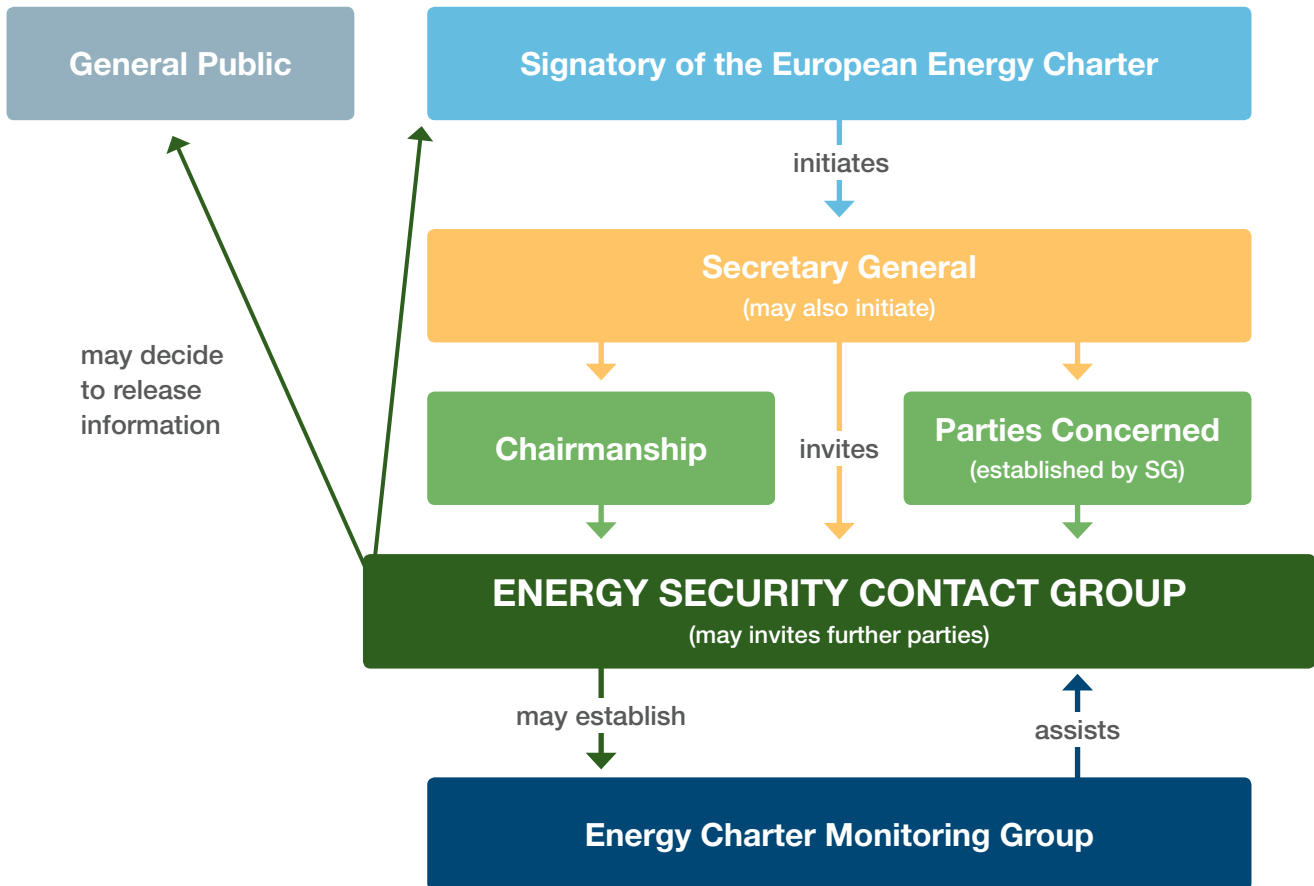

Figure 50. Functioning of the Model Energy Charter Early Warning Mechanism

representatives from any level: a country representative, an authorized person, an official from a diplomatic mission, or administrative officer. Representatives are not required to have an expertise in the energy field.

The Energy Security Contact Group is the core of the Model EWM. The Contact Group can be established either by request of any of the Parties Involved or by the Secretary General upon his own initiative. The Contact Group is a primary working body chaired by the Secretary General and includes representatives of the parties involved, the Chairmanship of the Energy Charter Conference (Vice-Chair of the Contact Group), and other invited parties (Art. 5.3).

The Contact Group encourages cooperation, and the exchange and analyses of information among the parties involved on issues they consider relevant. The Parties Involved may request the Chair to invite experts to provide additional information. The Contact Group has two objectives. Firstly, it proposes an agreed assessment of the situation and, secondly, it develops recommendations to eliminate the threat of an emergency situation, or to overcome an emergency situation (Art. 5.7). Recommendations refer to provisions agreed on by all parties involved and are in the nature of a “code of conduct,” without any legal obligation and enforcement.

At this level it is important that parties should share mutual confidence and provide the counterparty with the necessary information about the situation.

To establish the facts concerning the energy flows between countries involved, the Energy Charter EWM envisages the creation of a Monitoring Group. The composition of this Group as well as its terms of references is decided upon by the Energy Security Contact Group (Art. 6.2). The Monitoring Group can potentially include experts and monitors in a certain energy field (gas, oil, electricity). In practical terms, the monitors from the Group should be allowed access to the national dispatch centers in order to carry out necessary verification and control.

A Monitoring Group can be established, for example, because of the inability of the Contact Group participants to travel to places that require monitoring or when it is imperative to have independent members with monitoring expertise to ensure accuracy of data provided by the parties involved. The establishment of the Monitoring Group is optional. This working group can be established in case of a need to confirm information gathered within the Energy Security Contact Group (Figure 50).

The Energy Charter EWM is of a *multilateral nature*. The Energy Charter policy would be used as a forum, a neutral place for information exchange on developments, which may result in an energy security threat to a country or region. The EWM is an instrument for *preventive diplomacy* and *confidence building*. It provides a platform for cooperation and suggests solutions to overcome emergencies. The Model Energy Charter EWM is of a *non-legally binding* nature. It is based on full *transparency* and *neutrality*.

The EWM is *complementary* to existing mechanisms and does not duplicate them (Art. 4.2). Parties can refer to it voluntarily on a case by case basis. It will be complementary to other mechanisms for early warning and dispute resolution agreed bilaterally between individual parties.

The mechanism is not a dispute settlement mechanism, but an Early Warning Mechanism, meaning that it *does not aim to replace* any dispute resolution mechanisms provided by the Energy Charter Treaty (ECT). Its main objective is to prevent a real or potential crisis and to set up a neutral platform with voluntary participation of the countries involved to collect and share the relevant information before taking any further steps. The Secretary General facilitates the dialogue between the parties involved and ensures that possible misunderstandings, manipulations, and misuse of the data are avoided between them.

## The implementation of the Model Energy Charter EWM: 2014 Ukraine case

Although the Russian-Ukrainian gas disputes are perceived by the international community as political rather than commercial, the Energy Charter has made efforts to settle the situation from the energy perspective and within the Energy Charter legal framework.

The Energy Charter was prepared for possible energy security threats and on 3 March 2014 the Secretary General made a statement regarding the situation in Ukraine and initiated the Energy Security Contact Group on the Ukraine Crisis upon his own initiative to act in the spirit of partnership relations and international commitments (Art. 4.2). Only the Secretary General and parties involved can initiate a Contact Group meeting which is explained by the need to facilitate the decision-making process in a situation of high emergency.

On 5 March 2014, the first Energy Security Contact Group meeting with voluntary participation of the parties involved took place.<sup>27</sup> It was chaired by the Secretary General and consisted of the Kazakh, Russian, and Ukrainian representa-

tives from their respective diplomatic missions to the EU; and the EU's DG Energy and European External Action Service representatives.

During this meeting the parties exchanged views on the situation and possible implications for the flow of gas within the Energy Charter constituency. The Russian and Ukrainian representatives both reiterated their country's commitment to fulfil respective contractual obligations to avoid any interruption to energy flows. The Parties agreed to meet again one week later and thereby demonstrated their good faith and readiness to discuss the problem.

The second Contact Group meeting took place on 13 March 2014. Recognizing that transparency is the key for confidence building, the Secretary General proposed that a system for collecting relevant information on the physical gas flow should be put in place for the benefit of the Contact Group discussions. In other words, the Secretary General proposed that the Russian, Ukrainian, and EU parties should provide the Group with "daily actual flows ... daily nominations for flows of gas ... across borders from, through or to the areas of the parties involved; volumes transited as documented by the operators" (Art. 5.6).

After the events of the Crimea in March 2014, there was a need to de-escalate the tensions between Russia and Ukraine and to strike a line between political and energy confrontation. In his public statement from 17 March 2014, the Secretary General reminded the Russia and Ukraine of their international commitments with regard to energy security in the region and existing investors.<sup>28</sup> He reiterated that the Energy Security Contact Group was a neutral channel of communication and common evaluation, and encouraged the parties to continue participation.

At the third Energy Security Contact Group meeting at the end of March, the Secretary General repeated that the Energy Charter was a technical political body with a mandate to ensure the energy security of the constituency. For this reason, the parties were invited to discuss the outline of the Model Energy Charter EWM.

The last Energy Security Contact Group meeting was held on 4 April 2014. To advance and benefit the Contact Group discussions and build confidence among the parties involved, the Secretary General reiterated the need for the Energy Charter Secretariat to set up a system for collecting relevant data on physical gas flows. The Group was to reconvene again when the Russian and Ukrainian representatives had received instructions from the capitals concerning provi-

<sup>27</sup> For more information about all the Energy Charter Security Contact Group meetings see Energy Charter news items, <http://www.encharter.org/index.php?id=660&L=0> (accessed 15 November 2014).

<sup>28</sup> "Development of the Situation in Ukraine," Statement by the Secretary General, Brussels, 17 March 2014, [www.encharter.org](http://www.encharter.org) (accessed 28 November 2014).



sions of the necessary information, or concerning alternative suggestions to resolve the situation in the Contact Group.

Since April 2014, the Energy Charter Secretariat made efforts to reconvene the Security Contact Group. Another meeting was scheduled for the end of May and then rescheduled for June. The Secretary General suggested that at that meeting the Contact Group might assess the possibility of developing the proposal for the Ukrainian Government to implement the essential terms of the Early Warning Mechanism of the Energy Charter. However, the European Commission requested cancellation of the meeting due to the ongoing trilateral discussions between the Ukrainian, Russian, and EU representatives through its own intermediary. Since no progress was achieved, and due to the escalation of the conflict between Russia and Ukraine, further meetings of the Energy Charter Security Contact group were suspended. Despite this, the Secretariat, continues to maintain contact with the country representatives.

The March discussions in the framework of the Energy Charter did not give sufficient impetus to the rapid initiation of transparency regime. However, following the efforts of the Secretary General, some months later Ukraine introduced unprecedented transparency initiatives regarding gas flows on its territory.

As from 6 May 2014, PJSC Naftogaz of Ukraine, the leading gas transmission and storage company, joined Aggregate Gas Storage Inventory (AGSI+) transparency platform of Gas Infrastructure Europe (GIE). The information on the volume of gas available in Ukrainian underground storage facilities are reported, disaggregated by each storage facility, every Friday on the GIE website.<sup>29</sup>

Moreover, from 15 May 2014, PJSC “Ukrtransgaz,” a subsidiary of Naftogaz, started daily reporting on the volumes of natural gas transit through Ukraine’s gas transport system on their website and on the ENTSOG website.<sup>30</sup> These transparency initiatives are expected to provide improved interaction between Ukraine and international partners in the energy sector.

Another step by Ukraine towards transparency was its invitation to international observers to monitor gas transit via Ukrainian GTS. Thus, Ukrtransgaz was ready to provide official observers from the European Network of Transmission System Operators for Gas (ENTSOG, Belgium) and the Energy Community (Austria) with access to the Ukrainian gas measuring stations to monitor gas transit via Ukraine in June

2014.<sup>31</sup> The company has sent respective proposals to Brussels and Vienna, but no information on follow up has been made available. In November, Naftogaz again called on the EU to send observers to Ukraine to monitor gas flows.<sup>32</sup> It is worth mentioning that back in 2009 monitors were prevented from entering the dispatch centers in Ukraine. The invitation to international monitors by Ukraine reflects the third level of the Energy Charter EWM – establishment of a Monitoring Group. An acceptance by the party of different transparency procedures, including granting access to monitors to its national dispatch center on the voluntary basis, is at the core of the Energy Charter EWM. It is worth mentioning, that such a level of transparency and readiness to receive the monitoring mission on its territory was not expressed by Russia. There is thus no publicly available set of data for comparison between the Russia and Ukraine.

All the initiatives of the Ukrainian gas company Naftogaz and its subsidiary Ukrtransgaz with regard to joining various European data platforms will increase confidence in their international partners. Ukraine is willing to demonstrate that its gas transportation system is reliable and that its State-owned gas company with its shady reputation commits to international best quality business practices. Providing data on gas flows via Ukraine was a key recommendation by the Energy Charter Contact Group. Ukraine fulfilled it after the Contact Group ceased to meet. It should be noted however, that although not directly referred in the abovementioned initiatives, the Energy Charter EWM provided useful input and indirect influence in this matter.<sup>33</sup>

## Implications of EWM for electricity sector

The electricity supply, like the gas supply, is dependent on fixed infrastructure, which is characterized by a high degree of interconnectivity and complexity. If such infrastructure is vulnerable, especially when it comes to cross-border projects, a risk of disruptions and significant economic losses is posed. Regional cooperation in the electricity sector is a common phenomenon today to benefit from economies of scale and optimize the use of generation units. Therefore, international cooperation on the political and technical level is key to ensuring sustainable power supply and mitigating any risks of disruption.

<sup>29</sup> Gas Storage Europe, <http://transparency.gie.eu/> (accessed 28 November 2014).

<sup>30</sup> Ukrtransgaz, Operational Information, <http://utg.ua/utg/business-info/live.html> and EntsoG Transparency Platform <https://transparency.entsoG.eu> (accessed 28 November 2014).

<sup>31</sup> “Ukrtransgaz Ready To Allow European Observers To Control Implementation Of Transit Obligations”, 25 June 2014, Naftogaz news, <http://www.naftogaz.com/www/3/nakweben.nsf/0/6568DB532E812325C2257D080039D624?OpenDocument&year=2014&month=06&nt=News&> (accessed 10 April 2015).

<sup>32</sup> “Naftogaz increases transparency on gas transit, calls on EU to send observers to Ukraine to monitor gas flows”, 25 November 2014, Naftogaz news, <http://www.naftogaz.com/> (accessed 28 November 2014).

<sup>33</sup> Such as the Energy Charter Intergovernmental and Host Government Model Agreements in electricity and gas which furnish guidelines and a balanced starting point for new cross-border project agreements for new cross-border and transit infrastructure (i.e., Baku-Supsa Pipeline Project).

The operation of interconnected energy systems, independently of whether it is gas/oil pipeline or power grid, requires a certain degree of coordination. In the case of emergency, issues of transparency and coordination are even more important. Severe weather conditions and low temperatures caused emergency situation in Balkans in winter of 2012. Unfavorable hydro-meteorological conditions led to increased electricity consumption and limitation of exports, creating severe difficulties for EU common energy market.

Given the provisions of the Energy Charter Treaty prohibiting unjustified export restrictions, the possible effects of measures on transit within the region, and security of supply, the Secretariat called for maximum transparency with respect to any measures limiting the electricity export in the constituency and also reiterated that the measures applied to prevent or relieve critical shortage of electricity on domestic markets should not be employed for periods longer than necessary to achieve that objective. Now in a similar situation, each Contracting Party of the ECT or Signatory of the International Energy Charter can utilize the Early Warning Mechanism as a tool for transparency, coordination, and monitoring.

Under the ECT, the Contracting Parties are obliged to secure established flows of energy materials and products to, from, or between the areas of other Contracting Parties and shall not, in the event of a dispute over any matter arising from transit, interrupt or reduce or permit any entity to interrupt or reduce existing flows of energy materials and products prior to the dispute resolution procedures set out in Article 7(7) of the ECT, except where this is specifically provided for in a contract or permitted in accordance with the conciliator's decision (Article 7(6) of the ECT).

The Treaty highlights the significant principle of "freedom of transit" and obliges the Contracting Parties to facilitate energy transit on a "non-discriminatory" basis. In other words, the ECT acts as a safeguard of energy security of the ECT constituency, as the rationale behind freedom of transit is the non-interruption of transit and prevention of any obstruction to existing flows of energy.

Furthermore, the ECT imposes a soft law obligation on Contracting Parties to encourage Transmission System Operators (TSOs) to cooperate in measures to mitigate the effects of interruptions to energy supply (Article 7(2)(c) of the ECT).

Central Asia and the southern Caucasus are two important regions within Energy Charter constituency where electricity trade and transport are critical elements of energy security. Both regions are characterized by a high degree of vulnerability to geophysical (earthquakes) and climate-related disasters (floods, droughts, landslides).

According to the Central Asia and Caucasus Disaster Risk Management Initiative, UNISDR: "The countries of Central Asia and the Caucasus (CAC) have a history of devastating disasters that have caused economic and human losses across the region. Almost all types of natural and technological hazards are present, including earthquakes, floods, landslides, mudslides, debris flows, avalanches, droughts, and extreme temperatures. Earthquakes are the most dangerous hazard, causing destruction to human life, buildings and infrastructure alike, while also triggering secondary events such as landslides, mudslides and avalanches. This mountainous region provides compelling evidence of the destructive power of such secondary events: landslides, mudslides and debris flows caused most casualties during the earthquakes in Armenia (1988 Spitak), Azerbaijan (2000 Baku), Kazakhstan (1887, 1889, and 1911 Almaty), Kyrgyzstan (1992 Jalal-Abad), Tajikistan (1949 Khait, 1989 Gissar), Turkmenistan (1948 Ashgabat) and Uzbekistan (1966 Tashkent). Climate change is expected to exacerbate disasters associated with hydro-meteorological hazards."

The power systems of Central Asia and the South Caucasus inherited highly meshed and radial transmission lines as a legacy of the former Soviet Union. Both of these regional power systems used to be part of the unified power system of the Soviet Union which was designed and built under the command economy without taking into account national borders. This is still the case when part of the networks owned by one country crosses the border of the other one, making it difficult to react in case of emergency.

The growing need to address security risks is exemplified a number of large infrastructure projects in Eurasia which aim to facilitate cross-border electricity trade and transport. The CASA-1000 project developed by the World Bank stands for exports of hydropower surpluses from Central Asia to energy deficient countries of South Asia – Afghanistan and Pakistan. The initial concept of Gobitec and the Asian Supergrid projects is elaborated by the Asian Development Bank with the involvement of countries of northeast Asia. In large-scale projects like this, protection of infrastructure both from man-made and environmental risks is a top priority in order to generate the anticipated benefits.

The Model Energy Charter Early Warning Mechanism may be seen as a multilateral instrument of preventive energy diplomacy, confidence building, and emergency response based on voluntary cooperation. This instrument is especially relevant in light of the growing inter-regional infrastructure projects currently promoted throughout the Eurasian continent. Capital-intensive projects involving several countries would benefit from a framework which could address potential risks associated with critical energy infrastructure.



## Figures

Figure 1.	The synchronous European Transmission System. Source: ENTSO-E Memo 2012	12
Figure 2.	Summary of the N – 1 principle according to ENTSO-E Operational Handbook	13
Figure 3.	UCTE (now ENTSO-E) iso-risk curve.	14
Figure 4.	The essential patterns of resilient response behaviors	15
Figure 5.	The system split that occurred in the Western European transmission system in 2006	17
Figure 6.	Conceptual framework for the risk/vulnerability analysis of interconnected infrastructures	18
Figure 7.	Representation of the electric network	25
Figure 8.	Assessing cascading effects in a multi-risk framework	27
Figure 9.	Cascading effect scenarios triggered by earthquakes as example of implementing a multi-risk assessment framework considering an electricity transmission line	28
Figure 10:	Evaluation of the power outage in Italy on 28 September 2003	38
Figure 11.	Implementation of the assessed power outage in Italy on 28th September 2003 using blackout-simulator.com.	39
Figure 12.	Social acceptance of power infrastructure and grids in Europe	40
Figure 13.	Evaluation of perception-changing information campaigns	40
Figure 14.	Acceptance of energy infrastructures and share of renewable energy utilization	41
Figure 15.	Average effects of information campaigns vis-a-vis renewable energy presence.	41
Figure 16.	The future renewables-based power system in Europe requires new interconnections to transmit renewable electricity from remote generation sites to consumption centers and storage sites.	43
Figure 17.	Planning procedure for transmission lines	44
Figure 18.	Public participation levels in power grid planning	45
Figure 19.	Power grids: Technology depends on the voltage level	46
Figure 20.	NemoLink interconnector between England and Belgium, and Stevin project, Belgium	47
Figure 21.	Safety culture	48
Figure 22.	Just Culture Process	49
Figure 23.	Safety Message	50
Figure 24.	Power line damages caused by wind throw.	51
Figure 25.	Ice crusts damaging power lines in Carinthia, Austria, in winter 2014	51
Figure 26.	Per capita average minutes without electricity	52
Figure 27.	Damage parameters (for example, storm), grid topology, and number/type of households and companies, determining the vulnerability of grid infrastructure and the impacts of failure.	53
Figure 28:	Concerns according to five guiding principles	61
Figure 29:	Public information events in frames of BESTGRID project	62
Figure 30.	Rates of weather risk in colors, red representing the highest level and yellow the lowest.	63

Figure 31.	Broken overhead network lines	63
Figure 32.	Emergency restoration structures (ERS)	64
Figure 33:	Recent natural disasters in the Balkans	67
Figure 34:	consequences of natural disasters	69
Figure 35.	Key figures of those storms: wind speed from blue to red	70
Figure 36.	Key statistics of the consequences of the 1999 storms: (damage = number of towers)	70
Figure 37:	Emergency restoration training and cooperation	71
Figure 38.	The electricity generating and transmission systems in hazard-prone areas of Wenchuan County, Sichuan, China near the epicenter of the 2008 Wenchuan earthquake.	73
Figure 39.	Damaged Gengda Hydropower Plant (left) and nearby substation (right) near the epicenter of the Wenchuan Earthquake	73
Figure 40.	Risk and Crisis Management Cycle	78
Figure 41.	Assignment of tasks within the cooperative approach	79
Figure 42:	Basic structure of the electric system	83
Figure 43:	Resilience concept	84
Figure 44.	Sample Analysis Outputs	87
Figure 45.	Accumulation analysis for regulatory modeling or conflagration analysis for terrorism risk	88
Figure 46.	Identifying areas of peak exposure	88
Figure 47.	Developing a bespoke realistic disaster scenarios or post event calculations	89
Figure 48.	CAT risk engineering survey and PML assessment	89
Figure 49.	Very soft casual map/flow chart to capture main effects of extended power outages for human basic needs and possible emergency measures to avoid further risks.	90
Figure 50.	Functioning of the Model Energy Charter Early Warning Mechanism	93

## Tables

Table 1.	Major recent blackouts	16
Table 2.	Checklist for the categorization of hazards and triggered events in the EPS	20
Table 3.	Cases of natural disasters causing power losses	30
Table 4.	Overview of historic power interruptions, their dimension and their origin	35
Table 5.	Summary of historic power outages	36
Table 6.	WTP increasing factors for European households to avoid power cuts	37
Table 7.	Total losses across all regions and sectors; summary of blackout-simulator.com	38
Table 8.	Climate impacts and risks for electricity transmission and distribution	54

# Authors and organisations

## AMRA (Center for the Analysis and Monitoring of Environmental Risk)

AMRA is an entirely public, non-profit organization formed by five public Universities from the Campania Region (Italy) and three national public research institutes (CNR, INGV and the Zoological Station “Anton Dohrn”). AMRA operates in the fields of natural and anthropogenic risk assessment and mitigation, including the assessment of environmental impacts associated with energy technologies. Early warning methods and quantitative probabilistic multi-risk assessment methods have historically been the core of its activities. Recently, assessing environmental impacts of energy technologies have become one of AMRA’s most strategic research fields.



### Alexander Garcia-Aristizabal

PhD in Geophysics, is a senior researcher in AMRA. His main interests include Bayesian data analysis, stochastic modeling in geophysics, and computational methods for stochastic processes. His research activities are mainly centered in the use of Bayesian methods applied to inverse problems in geophysics, extreme value analyses, multi-hazard and multi-risk assessment.

## Center for Disaster Management and Risk Reduction Technology

The Center for Disaster Management and Risk Reduction Technology (CEDIM, [www.cedim.de](http://www.cedim.de)) is an interdisciplinary center within the Karlsruhe Institute of Technology (KIT) aiming at the development of risk assessment methodologies, in the context of natural disasters. Since 5 years the Center focuses on near-real time (forensic) damage assessment in case of earthquakes, tropical cyclones, and floods. As indirect losses, caused by the interruption of services, play an increasing role in developed societies our current focus shifts to infrastructure losses and the development of concepts to increase the resilience of critical infrastructure, including power supply networks. CEDIM is part of the IRDR initiative sponsored by ICSU.



### Prof. Friedemann Wenzel

Friedemann Wenzel (born 1951) is Professor at and Director of the Geophysical Institute of Karlsruhe Institute of Technology (KIT). Before his PhD at Karlsruhe University in 1985 he was Research Scientist at Lamont-Doherty Geological Observatory of Columbia University, New York (1979 – 1981). After 3 years as Associate Professor at the Geophysical Institute Karlsruhe he became Principal Research Scientist for the Commonwealth Scientific and Industrial Research Organization, Division of Exploration Geoscience, Sydney, and Fellow at School of Earth Sciences of Macquarie University, Sydney (1990 – 1992), Director of the Department ‘Structure of the Earth’ at GeoForschungs Zentrum Potsdam, and Professor of Geophysics at Potsdam University (1992 – 1994), and in 1994 Professor at the Geophysical Institute in Karlsruhe. From 1996 to 2006 he coordinated the Collaborative Research Center: ‘Strong Earthquakes - A Challenge for Geosciences and Civil Engineering’ at Karlsruhe University, funded by the National Research Foundation (DFG); acted as Editor in Chief of TECTONOPHYSICS between 1996 and 2001; established in 1998 as co-leader (jointly with Dr. Fouad Bendimerad, U.S.) the ‘Earthquake and Megacities Initiative’ operating under the umbrella of UNESCO and ICSU; coordinated between 2006 and 2012 CEDIM (Center for Disaster Management and Risk Reduction Technology); served between 2000 and 2004 as vice-chairman of the German Committee for Disaster Reduction and chairman of its Scientific Board; is 2002 member of the Heidelberg Academy of Science and Humanities; since 2003 professor Honoris Causa of Bucharest University; since 2006 member of the Academia Europaea. Research interests between 1979 and 1994 focused on methods for reflection seismic data processing, and numerical modelling of elastic wave propagation including applications in the hydro-carbon industry. As director at GFZ in Potsdam he initiated GFZ’s national instrumental program for digital geophysical field measurements. Since 1994 research interests focused on engineering seismology, geophysical hazards and risks, urban risk management, seismic loss estimation, and development of resilient systems.

## Consulting company CESys Ltd.



### Lubomir Tomik

Director of consulting company CESys Ltd. working in the field of energy and safety. After graduating ČVUT, Faculty of Engineering with specialization on nuclear energy he worked in SE, a.s as a control room engineer for NPP V1 (SE,a.s.-Npp operator in Slovakia).During establishing of Nuclear Regulatory Authority of the Slovak Republic he worked in the field of probabilistic safety assessment and nuclear inspection. Over transition economy in 90' he gained experience in abroad in number of industry and energy companies. During last years he worked as manager in foreign IT companies solving the opening and deregulation of CZ & Slovak energy market. During the period of 2002 – 6 he was managing director of CENS (Centre for Nuclear Safety), international company working on the region of Central and Eastern Europe, focusing on Enhancement of Nuclear safety with close cooperation with IAEA. Regarding the SE, a.s., privatization he is author and co-author of various studies performing energy market scenario modeling, i.e. Feasibility Study on NPP Mochovce 3 and 4 Completion for Ministry of Economy of the Slovak Republic. He is occupied by publication activities, mainly in the field of nuclear power industry and has wide experience in organizing of international and specialized professional conferences and meetings. He is co-author of several training courses devoted to Nuclear safety( Understanding of Nuclear safety, Safety culture and questioning attitude, etc.) CESys act as certified body (Ministry of education of SR) for training in safety related topics.



## Electro Ljubljana

Mission, Vision, Values <http://www.elektro-ljubljana.com/2/About-Us/Mission-Vision-Values.aspx> Mission: We network with positive energy. Elektro Ljubljana provides a reliable, safe, quality and sustainable electricity distribution system by combining the most advanced services from the field of power supply. Elektro Ljubljana has been integrating the needs of its consumers, owners and employees for more than 115 years. Vision: By providing efficient, innovative and comprehensive solutions in the field of power supply Elektro Ljubljana remains the leading partner in the development of energy industry at the national and local levels as well as the leading company for the management of modern electricity infrastructure network entailing a pertinent yield for the owners and a motivating environment for the employees.

Elektro Ljubljana promotes dialogue with the employees, owners, partners in projects and wider environment. Elektro Ljubljana develops the best long-term solutions for all the stakeholders. Threats and opportunities are combined and exceeded with system services (solutions) entailing above-average quality and value added. Tradition is combined with innovativeness, knowledge with curiosity. Elektro Ljubljana propels a cycle of environmentally-friendly technological development.



### Matjaž Keršnik

Matjaž Keršnik is the head of maintenance and development coordination service, operation and development of distribution network, Electro Ljubljana. He is also a member of the international committee of CIGRE.

## Energy Charter Secretariat

The role of the Energy Charter Secretariat is to, primarily, provide the Energy Charter Conference, as the main decision-making body, with all necessary assistance for the performance of its duties and carry out the functions assigned to it in the Energy Charter Treaty or in any Protocol and any other functions assigned to it by the Charter Conference. The Secretariat is thus responsible to and reports to the Charter Conference.

The Secretary General is the main representative of the Secretariat who is appointed by the Energy Charter Conference for a maximum period of five years on a first appointment.

The Secretariat's functions are:

- to monitor implementation of the Energy Charter Treaty and Protocol's obligations;
- to organise and administer meetings of the Energy Charter Conference and its subsidiary bodies;
- to provide analytical support and advice to the Energy Charter Conference and its subsidiary bodies on all aspects of the Energy Charter Process;
- to represent the Energy Charter Conference in the development of its relations with non-member states and other relevant international organisations and institutions;
- to support negotiations on new instruments mandated by the Conference.



**Kanat Botbaev** | Expert - Transit, Energy Charter Secretariat.

Kanat Botbaev joined Energy Charter Secretariat in June 2012. He is a graduate of the American University in Central Asia. He has extensive experience both in public and private sectors. He started his career in the State Energy Agency – the regulatory commission for the energy sector in the Kyrgyz Republic. He also dealt with the coordination of energy investment projects during his service in the State Investment Commission and the Ministry of Finance. He has over ten years of professional experience of dealing with the transboundary water and energy issues in Central Asia, electricity demand management programs, development of least-cost expansion plans for power sector, audit of management practices of power distribution utilities and other projects. Currently, as a member of the Secretariat's team he is responsible for the support of the Trade and Transit Group and coordination of the activities related to regional energy cooperation, including Central and South Asia, South Caucasus and Northeast Asia.



**Iryna De Meyer** | Junior Legal Assistant, Energy Charter Secretariat

Iryna De Meyer joined Energy Charter Secretariat in October 2013. She is a graduate of the University of Maastricht (Master in European Law) and Free University of Brussels (Advanced Master in International Business Law). She started her career as a Trade Coordinator at the Energy Charter Secretariat, and was responsible for implementation of trade provisions of the Energy Charter Treaty (ECT), monitoring developments in the WTO (Environmental Goods Agreement negotiations), as well as organization of Energy Charter workshops and seminars in the WTO premises in Geneva. She made a research on gas transit issues between Ukraine and Russia and potential of the Energy Charter Model Early Warning Mechanism ('The Energy Charter Early Warning Mechanism: 2014 Russia-Ukraine-EU Transit Issues', by U. Rusnák, I. De Meyer, Energy Charter Secretariat). Currently, as a member of the Secretariat's legal department, she is working on the legal commentary to the ECT provisions and provides a general support to the Legal Council of the Secretariat.

## Environment Energy Agency (EEA)

The EAA is the Austria's largest organisation of experts on all environmental issues. As an independent partner, the institution builds bridges between the economy, science and politics at national and international level. With more than 450 experts in 55 academic disciplines the EAA is a leading provider of environmental solutions. In the field of climate impacts, vulnerability of and adaptation for electricity grids the EAA gained expertise via several projects delivered in recent years. The EU DG Climate financed projects on climate proofing EU policies as well as the background report for the European Adaptation Strategy were important steps to emphasize the necessity to adapt the European energy system (including supply, demand and transmission/distribution) towards more resilience. Find the background report including the energy chapters at [http://ec.europa.eu/clima/policies/adaptation/what/studies\\_en.htm](http://ec.europa.eu/clima/policies/adaptation/what/studies_en.htm)

The Austrian climate and energy fund (KLIEN) finances via its ACRP program the project Switch-Off (stands for Shifts in Weather Incidents Threatening reliability of the electricity distribution and transmission/economic performance due to climate Change & Opportunities For Foresight planning), in which the project consortium (University of Natural Resources and Life Sciences, Environment Agency Austria and Energy Institute at the University of Linz) investigates current and future climate vulnerability of e-grid infrastructure, its economic performance under climate change and elaborates adaptation needs.



### Martin König

Martin König was a senior expert at the Environment Agency of Austria. He coordinated activities on setting up national CCIVA research programs, initialized and coordinated EU projects for better cooperation of national climate research programs throughout Europe (CIRCLE) and was involved into adaptation projects providing background, instruments and DSS for different sectors and scales—from regional via national to European. For him, his involvement in various climate impact studies was one important base for meaningful policy consulting on response strategies.

## Energy Institute at the Johannes Kepler University

The Energy Institute at the Johannes Kepler University Linz is a not for profit research organisation, with multidisciplinary knowledge about energy-related research topics. The Energy Institute's three departments cover Energy Economics, Energy Law and Energy Technologies. The combination of these core disciplines allows comprehensive analyses and accounts for all aspects of future-oriented energy topics. We analyse the economic effects of questions regarding energy-related policy, discuss the most recent developments in the European energy legislation and evaluate strategies for CO<sub>2</sub> abatement schemes as well as measures aimed at promoting energy efficiency goals. The Energy Institute at the Johannes Kepler University Linz is deeply rooted in the Austrian research community, publishes in high level journals and possesses experience in numerous national and European research projects, among them large multinational projects about the security of Europe's electricity supply. The energy security related research efforts at the Energy Institute focus on the provision of decision support. Related analyses range from economic assessments of the value of security and thereby provide guidance about economic efficient investment levels, to the public perception and acceptance of security related policies.



### Johannes Reichl

Johannes Reichl is an applied statistical researcher who develops advanced econometric methods while investigating the challenges facing society in the fields of energy and resource economics. Currently he is the scientific coordinator and principal investigator of the Horizon 2020 project "Personal Energy Administration Kiosk application" (PEAKapp), a Task Manager of the Horizon 2020 project "Innovative Large Scale Energy Storage Technologies & Power-to-Gas Concepts after Optimisation" (STORE & GO), and is the Legal, Ethical, Privacy and Policy Issues (LEPPI) Officer in the FP 7 project "Smart Grid Protection Against Cyber Attacks" (SPARKS). Furthermore, he was the vice-coordinator of the FP7 project "Securing the European Electricity Supply Against Malicious and Accidental Threats" (SESAME), and was the chief developer of the software package [www.blackout-simulator.com](http://www.blackout-simulator.com). He has organised and moderated a number of high level policy maker workshops on energy related topics, such as the 2016 workshop "Smart Grids Security Requirements: Economic, Legal and Societal Aspects" in the European Parliament, Brussels, and the 2012 workshop "Emerging Malicious Threats to Electricity Infrastructure: Awareness and Preparedness of Professionals in TSOs and National Security Agencies" in the European Commission, Directorate-General for Home Affairs, Brussels.



### Michael Schmidthaler

Dr. Michael Schmidthaler is a project manager at the Energieinstitut at the Johannes Kepler University Linz. He completed his Doctorate at the Johannes Kepler University Linz, holds Masters in Economics and Environmental System Sciences (M.A & M.Sci with distinction) from the Karl-Franzens University of Graz and gained international experience in various research stays in the USA, Hawaii, Spain and South America. For several years he has been working on a variety of projects with a focus on quantitative analyses of energy supply security (2010-2015), on regulatory schemes (2011-2014), on smart metering and grid services, as well as on the economics of greenhouse gas abatement actions and energy efficiency efforts. He is task leader in the FP 7 project SPARKS, conducted part of the regulatory assessment in the FP 7 project SESAME and is project/work package leader in national energy, security and efficiency research efforts

## Energy Community Secretariat

The Energy Community is an international organisation which brings together the European Union and its neighbours to create an integrated pan-European energy market. The organisation was founded by the Treaty establishing the Energy Community signed in October 2005 in Athens, Greece, in force since July 2006. The key objective of the Energy Community is to extend the EU internal energy market rules and principles to countries in South East Europe, the Black Sea region and beyond on the basis of a legally binding framework.

As of January 2016, the Energy Community has nine members: the European Union and eight Contracting Parties - Albania, Bosnia and Herzegovina, Kosovo\*, former Yugoslav Republic of Macedonia, Moldova, Montenegro, Serbia and Ukraine. Georgia, Armenia, Norway and Turkey participate as Observers. ECDSO-E is established as a discussion forum and a coordination platform of distribution system operators from the Energy Community, set up to facilitate discussion, experience sharing, exchange of views and initiatives among experts interested in the distribution system operation.



### Milka Mumovic

Milka Mumovic is the electricity and statistics expert in the Energy Community Secretariat, Vienna. Before joining the Energy Community Secretariat in 2009, Ms. Mumovic was working for the power utility Elektroprivreda Republike Srpske during implementation of the power reconstruction project in Bosnia and Herzegovina and for the Regulatory Agency for Energy of Republic of Srpska. Her key competences are related to economics of energy businesses and price regulation, business analysis, financial and accounting control, cost structure and tariff design. In the Energy Community Secretariat, in addition to monitoring implementation of the Treaty in the matters of electricity market and statistics, she is responsible to handle and moderate peer consultation and experience sharing within an electronic coordination platform for DSOs from the Energy Community (ECDSO-E).

\* All references to Kosovo, whether to the territory, institutions or population in this text should be understood in full compliance with UNSCR 1244

## Federal Office of Civil Protection and Disaster Assistance

The Federal Office of Civil Protection and Disaster Assistance (German: Bundesamt für Bevölkerungsschutz und Katastrophenhilfe – BBK) is a federal authority within the portfolio of the Federal Ministry of the Interior. It fulfils tasks relating to civil security measures in close cooperation with the German States (Länder), but also with authorities at all levels of the administration, as well as organisations and institutions working in civil protection. Some examples of its tasks are the coordination of a national risk analysis, the development of framework concepts for civil protection, the warning and information of the population, education and training of decision makers and managers from the sector of civil security measures, and cooperation with infrastructure operators on critical infrastructure protection.



### Christine Eismann

Christine Eismann works in the division for Critical Infrastructure Protection Concepts, with a focus on energy infrastructures. She has been in charge of different projects on blackout prevention and preparation, and has cooperated in different work groups with operators and authorities on critical infrastructure protection. Before joining the Federal Office of Civil Protection and Disaster Assistance, she has conducted risk research at the University of Bonn, Department of Geography.

## GO15

GO15. Reliable and Sustainable Power Grids is a voluntary initiative of the world's 17 largest Power Grid Operators representing more than 70% of the world's electricity demand and providing electricity to 3.4 billion consumers on the 6 continents. Following several severe weather related incidents in different continents, GO15 members decided to put Grid resilience on their joint agenda. It goes without saying that for low probability/high impact events experience exchange is extremely important. Preventive and corrective measures are benchmarked, including costs assessments for improving grid reliability. Eventually, members agreed on a framework for mutual assistance. Improving electric power grid resilience will engage important amounts of investments. Therefore, it is a shared responsibility among federal agencies, state and local regulatory entities and industry partners. GO15 promotes a better mutual understanding for the development of the worldwide power grids. GO15 brings together an international network of experts who share best practices and experiences to address the challenges of the increased complexity of very large power grids by ensuring that consumer needs are met by means of providing safe and reliable power supply at reasonable costs. The common vision and recommendations of the 17 members are shared with relevant shareholders like regulators, decision makers, manufacturers and research centers. GO15 joint activities are organized into five Committees that address the operational, technological, financial and communication aspects.



### Hubert Lemmens

Hubert Lemmens obtained a Master in Engineering from the Katholieke Universiteit Leuven (1977). He also holds a degree from the Vlerick Business School and the "General Management Program" from CEDEP in Fontainebleau (2000). After several positions in the Electricity sector, he joined in 2003 the Elia Management Board, where he was successively Director of System Operation, Maintenance and Research and Innovation. He was deeply involved in the unbundling process and the start up of the Belgian System operator Elia from 1999 on. Hubert chaired the ENTSO-E R&D committee for 3 years and lead the development of the first R&D Roadmap of ENTSO-E. In the course of his career Hubert build a broad experience in Power economics. Trough his international contacts with European and global power companies, he had the opportunity to get familiarized with different business models and organisations in the power sector.



### Terry Boston

After serving as president and CEO of PJM since 2008, Mr. Boston retired at the end of 2015. Mr. Boston is past president of GO 15, the association of the world's largest power grid operators. In 2014 Mr. Boston was elected to the National Academy of Engineering, one of the highest professional honors accorded an engineer. Mr. Boston was honored with several other professional awards in the US. He is chair of the Electric Infrastructure Security Council E-PRO executive committee. He served on the board of Electric Power Research Institute, is currently on the Boards of GridLiance GP LLC, Grid Protection Alliance and the National Academy's Board on Energy and Environmental Systems. Mr. Boston holds a Bachelor of Science in engineering from Tennessee Technological University and a Master of Science in engineering administration from the University of Tennessee.



## Alain Steven

Alain Steven has over 47 years of experience in the electric power industry, including 30 years as a senior executive, with focus on real-time mission critical systems for demand side management, energy markets, grid management, nuclear and fossil power plants. Alain Steven is Secretary General for GO15, an international association of the largest Power Grid and Market Operators in the world. He is also the CTO of Advanced Microgrid Solutions, a San Francisco based company using advanced storage technologies to provide grid operators with load relief while helping consumers reduce their electricity bills. He was CTO and co-founder of Viridity Energy, a company specialized in advanced Demand Response services, and is the author of seven patents. Prior to Viridity, Alain held senior executive positions as CTO of the PJM Interconnection, President of PJM Technologies, CEO of Alstom ESCA Corporation and Vice President Simulator Business at ABB Combustion Engineering. He graduated from the University of Liège (Belgium) in 1968, where he earned a degree of Engineer in Physics and Aerospace.



## Human and Environment Linkage Program

Human and Environment Linkage Programme (HELP) is a 510(c)3 not-for-profit organization based in the California, USA and Beijing, China. HELP focuses on the intersection of disaster risk management, community development and environment conservation in ecologically fragile regions in the developing world, with a current geographical emphasis in Southwest China. HELP works with a variety of stakeholders across public, private, academic and civil society sectors to jointly support communities facing multiple challenges to pilot and practice integrated and adaptive management strategies to build resilience and pursue sustainability transitions. Since 2012, HELP works in China as a subsidiary of Cheung Kong Philanthropy Fund under the Chinese Red Cross Foundation. A priority in HELP's mission is to promote resilience thinking and practices, through on-the-ground implementation, rigorous science, and innovative communication, in the public and civil society sectors in China.

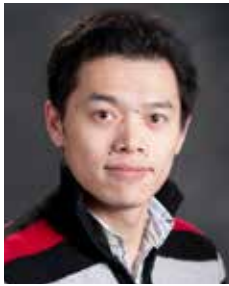

### Wei Liu

Dr. Wei Liu was trained in Biology and Economics at Peking University in China and later received his MS in Ecology at Iowa State University and PhD in Conservation Development at Michigan State University in the USA. His research encompasses disaster risk management, socioeconomic development and ecosystem management. He has authored and co-authored ~30 peer reviewed articles in top international journals, such as *Ambio*, *Biological Conservation*, *Journal of Environmental Management*, and *PNAS*, and provided consultancy services to a number of governmental agencies and international non-governmental organizations, such as UNESCO and IUCN, often on the topics of social-ecological, climate and/or disaster risk and resilience. He is the co-founder and executive director of Human and Environment Linkage Programme, a US and China based NGO focusing on community-based DRM, conservation and poverty reduction. As a Research Scholar in the Risk and Resilience program of International Institute for Applied Systems Analysis (IIASA), he works with scientist and practitioner collaborators to combine scientific research methodology with stakeholder participatory processes and citizen science approaches to explore innovative solutions for enhancing disaster resilience of communities in Nepal, Indonesia and other countries. His currently research at IIASA, including the writing of this chapter, is supported by the Zurich Flood Resilience Alliance.

## International Institute for Applied Systems Analysis (IIASA) and ETH Zurich

IIASA is a scientific institute located in Laxenburg, nearby Vienna. The Risk and Resilience (RISK) Program at IIASA aims to better understand the risks to economic, ecological, and social systems arising from global change and to help transform the ways in which societies manage them. The Governance in Transition research theme analyzes how governance structures shape decisions and subsequent outcomes by building on and contributing to research on decision-making processes, public acceptance, risk perception, cognitive biases, and cultural perspectives, as well as participatory governance design.

Climate Policy Group at the ETH Zurich conducts problem-driven research on the strategies to address climate change and related environmental problems. Currently the group focuses on analyzing pathways for creating a sustainable electricity system for Europe and beyond, the means to mitigate human vulnerability to climate and other natural hazards, and the effects of policies on the use and protection of natural resources.



### Nadejda Komendantova

Dr. Nadejda Komendantova is senior research scholar at the Climate Policy Group at ETH Zurich, Switzerland and a coordinator of the research theme 'Governance in transition' within the RISK Program at IIASA, Austria. Her research interests include participatory and multi-risk governance of climate change mitigation and adaptation, based on the understanding of views and risk perceptions of involved stakeholders, of governance structures, market and civil society as well as social institutions and political processes towards more adaptive and inclusive governance approach, which is central to the science-policy interface. Dr. Komendantova is currently a principal investigator of the project 'Linking climate change mitigation, energy security and regional development in climate and energy model regions in Austria' (LINKS) project, supported by the Austrian Climate Research Program. She is also involved into the project 'MENA Sustainable ELECTricity Trajectories Energy for sustainable development in North Africa and the Middle East' (MENA-SELECT) supported by the German Federal Ministry for Economic Cooperation and Development (BMZ). The work of Dr. Komendantova includes more than 60 publications, including contributions to Global Corruption Report (Transparency International), Global Assessment Report (GAR) report and Global Renewable Energy Report (REN21). She was granted awards from the Academic Council of the United Nations as well as the Julius Raab Foundation. She received a number of invitations to speak at high-level forums such as at the Directorate General for Research and Innovation of the European Commission, NATO, Energy Community Secretariat and Energy Charter Forum.

## Organization for Co-operation and Security in Europe

### Office of the Co-ordinator of OSCE Economic and Environmental Activities

The OSCE has a comprehensive approach to security that encompasses politico-military, economic and environmental, and human aspects. It therefore addresses a wide range of security-related concerns, including arms control, confidence- and security-building measures, human rights, national minorities, democratization, policing strategies, counter-terrorism and economic and environmental activities. All 57 participating States enjoy equal status, and decisions are taken by consensus on a politically, but not legally binding basis.

OSCE economic and environmental activities incorporate energy security, including the protection of critical energy networks, a dialogue on strategic security related energy issues and renewable energy and energy efficiency. As a pan-European and trans-Atlantic platform, the OSCE supports an energy security dialogue among its participating States and other international bodies that deal with energy issues.



#### Daniel Kroos

Daniel studied Law, Business and International Relations in Berlin and Washington DC. He has advised Policy Planning Council of the German Federal Foreign Office in Berlin, the European Commission in Brussels and British Petroleum in Baku, Azerbaijan on energy issues.

From 2008-2010 he served as Deputy Director of the German Chamber of Commerce in Baku, Azerbaijan. Before joining OSCE he led the oil & gas practice as Vice President of BTO Management Consulting AG in Berlin and Zürich, managing international projects in M&A, post-merger integration and optimization in the oil & gas industry.

Daniel currently serves as Senior Programme Officer for Energy Security at the Office of the Co-ordinator of Economic and Environmental Affairs (OCEEA) at the OSCE Secretariat in Vienna, advising on regional energy security issues as well as renewable energy.

## RTE

RTE is the French transmission system operator and has to provide economical, reliable and clean access to electrical power, regarding 3 objectives: optimizing operation of the French power system, second by second, seeing to the security of supply for our customers, with access to economical, reliable and secure electricity, now and tomorrow and adapting the transmission system to facilitate the energy transition. With nearly 105,000 km of lines, RTE operates a largest grid in Europe. 46.2% of extra-high voltage lines (400,000 and 225,000 volts) transmit electricity over long distances and to 48 cross-border connections with the neighboring countries. The lines at 150,000, 90,000 and 63,000 volts are designed for regional sub-transmission. RTE fosters constant dialogue with his European partners, specifically through the European Network of Transmission System Operators for Electricity, ENTSO-E, of which he is an active member.



### Eric Andreini

Since 1983, the career of Eric within EDF and RTE included performance of different jobs in the field of generation and transmission energy, particularly in maintenance, engineering and management of teams as for the activities of French electric network, such as Deputy Director of RTE's regional area for Paris and Normandy, General Manager of RTE's regional control center for Finance West area and Engineer graduate of the Ecole Nationale Supérieure d'Arts & Métiers

Eric joined the European Affairs Division at its inception in January 2012. He is in charge of the topics of asset management, maintenance and engineering of the grid at the European level. Thus, he is a chairman of the working group Asset Implementation and Management of ENTSO-E. He also assures the internal coordination for RTE of the ENTSO-E's activities in Asset Management and does the link with the operational departments of RTE specially National Expertise, Maintenance and R&D.

## Swiss Federal Institute of Technology Zurich (ETH)

Laboratory for Safety Analysis led by Prof. Dr. Wolfgang Kröger was established in 1990 within the Institute of Energy Technology at the Department of Mechanical and Process Engineering, ETH Zurich. Research and teaching activities have been focused on the modeling and simulation of large-scale technical systems with regard to reliability, vulnerability and risk. We have developed frameworks, methods and tools to meet current requirements and future challenges to systems design and operations. Main projects aimed at (a) providing methods and data suitable to model, analyze/simulate and optimize complex engineered systems such as critical infrastructures in the energy, transportation and ICT domain, and their interconnectedness, (b) developing a framework for comprehensive risk and vulnerability analysis and related management strategies, (c) providing tools for decision making processes and applying them within programs of critical infrastructure protection. Furthermore, efforts have been made to put technical risks into a broader societal context and to shape evolving concepts such as “resilience”.



### Prof. Dr.-Ing. habil. Wolfgang Kröger

Wolfgang Kröger, born in Germany, has been full professor of Safety Technology at the ETH Zurich since 1990 and director of the Laboratory for Safety Analysis, Department of Mechanical and Process Engineering. Simultaneously, before being elected Founding Rector of the International Risk Governance Council (IRGC), Geneva, in 2003 he headed nuclear energy and safety research at the Swiss national Paul Scherrer Institut (PSI), where he was also on the board of directors. After his retirement early 2011 he became the executive director of the newly established ETH Risk Center and stepped back from this position by end of 2014. Presently he is acting as an advisor and consultant on future technical systems. Prof. Kröger studied mechanical engineering at the RWTH Aachen, Germany, and completed his doctorate in 1974, his habilitation thesis followed in 1986. Nowadays, he is chiefly involved in methodical issues pertaining to modelling and analysis of complex interdependent technical systems like critical infrastructures. He strives for reducing associated risks and to increasing their resilience. He is engaged in putting the assessment and management of technological risks into a broader context and providing advanced tools for decision-making processes. Inter alia he is elected member of the Swiss Academy of Engineering Sciences heading the topical platform “Risk” and has been awarded “Distinguished Affiliate Professor” by the TU Munich. Most recently, he is member of the International Review Group of the Japanese Nuclear Safety Institute and served on the ad-hoc Advisory Group on “EU Energy Roadmap 2050” and as expert on OSCE missions to Armenia, Georgia and Belarus. He authored/ contributed to numerous publications and books, the latest on “Radioactive Waste”, “Vulnerable Systems”, “Networks of Networks”, all published by Springer.

Reliability and Risk Engineering Laboratory led by Prof. Dr. Giovanni Sansavini was established in June 2013 within the Institute of Energy Technology at the Department of Mechanical and Process Engineering, ETH Zurich. Research at the Reliability and Risk Engineering Laboratory is aimed at the development of hybrid analytical and computational tools suitable for analyzing and simulating failure behavior of engineered complex systems. We aim to quantitatively define and estimate reliability, risk and resilience within these systems. We focus on highly integrated energy-carrier networks, energy supply with high penetrations of renewable energy sources, communication, transport, and other physically networked critical infrastructures. Our main research areas include: modeling and protection against cascading failures in interdependent energy-carrier networks, e.g. electric power and gas supply systems; vulnerability analysis of interdependent cyber-physical infrastructures, e.g. Smart Grid communication networks; optimum performance restoration after disruptions; decision making for energy systems under uncertainty.



### **Prof. Dr. Giovanni Sansavini**

Giovanni Sansavini joined ETH Zurich in June, 2013, as an Assistant Professor of Reliability and Risk Engineering in the Department of Mechanical and Process Engineering (D-MAVT). He received his B.A. in Energy Engineering in 2003 and his M.A. in Nuclear Engineering in 2005 from Politecnico di Milano (POLIMI). In 2010, as a member of the Atlantis Dual Doctoral Degree Program, he received his Doctoral Degree in Radiation Science and Technology from POLIMI and his Doctoral Degree in Mechanical Engineering from Virginia Tech. His doctoral dissertations aimed at developing a methodology for critical infrastructure vulnerability assessment from the standpoint of complex systems theory.

## Virginia Tech

Virginia Tech (VT) is a public land-grant university founded in 1872 in the State of Virginia, USA. Virginia Tech is dedicated to the discovery and dissemination of knowledge through teaching, research, and engagement with the community, following its motto “Invent the Future.” One of VT’s priority objectives is international collaboration, such the efforts between the Energy Institute at JKU and VT’s Department of Agricultural and Applied Economics (AAEA) that led to this book chapter. The AAEA department at VT has traditional research strength in environmental and energy economics, applied econometrics, food and health economics, development economics and international trade.

The Pamplin College of Business is ranked among the top 50 undergraduate business schools in the United States by U.S. News & World Report. It is one of eight different colleges at Virginia Tech, which offers 240 undergraduate and graduate degree programs to more than 31,000 students. Virginia Tech manages a research portfolio of \$513 million, including a number of projects in resilience, communications, and sustainable electric power.



### Christopher Zobel

Christopher W. Zobel is the R.B. Pamplin Professor of Business Information Technology in the Pamplin College of Business at Virginia Tech. He earned a Ph.D. in Systems Engineering from the University of Virginia, and an M.S. in Mathematics from the University of North Carolina at Chapel Hill. His primary research interests include disaster operations management and humanitarian supply chains, and he has published his work in journals such as *Decision Sciences*, *Decision Support Systems*, and the *Journal of Humanitarian Logistics and Supply Chain Management*, among others. He is one of the co-editors of *Advances in Managing Humanitarian Operations*, which is part of Springer’s International Series in Operations Research & Management Science. Dr. Zobel is currently serving as one of the Co-Directors of Virginia Tech’s Interdisciplinary Graduate Education Program in Disaster Resilience, and he was a 2015 Fulbright Scholar in Karlsruhe, Germany. He is on the Board of Directors of the International Association for the Study of Information Systems for Crisis Response and Management (ISCRAM), and he is an active member of the Decision Sciences Institute (DSI), the Institute for Operations Research and the Management Sciences (INFORMS), and the Production and Operations Management Society (POMS).



## Klaus Moeltner

The VT authors, Klaus Moeltner and Jed Cohen, both work within the environmental and energy economics, and applied econometrics field groups. They have been engaged in research on energy reliability and economic implications of power outages for the last several years. Dr. Moeltner is an economist with expertise in environmental and resource economics and applied econometrics. The primary focus of his research program is to estimate the monetary value to society of environmental amenities and natural resources, such as clean air and water, forest health, reduction of flood risk, reliable energy, and recreational opportunities. These values are critical for an informed comparison of benefits and costs of environmental policy interventions. In recent years, Dr. Moeltner has fostered collaborative efforts between the Energy Institute (EI) at the Johannes Kepler University (JKU) in Linz, Austria, and his own workplace in the United States, Virginia Tech (VT) University in Blacksburg, Virginia. As part of this collaboration, he participated in several grant-funded projects on energy reliability and the acceptability of energy-related infrastructure that were administered by the EI-JKU. He was the keynote speaker at the symposium on the “Public Acceptance of Electricity Infrastructure,” held at JKU in June 2014. Over the years Dr. Moeltner published in all leading journals of his field, as well as in highly ranked journals of general economic interest. He was the PI or Co-PI for over 20 grant-funded projects totaling close to \$3 million. He also holds the position of Co-editor for *Environmental and Resource Economics*, a top field journal.



## Jed Cohen

Jed Cohen is a PhD candidate and researcher in the Applied and Agricultural Economics Department at Virginia Tech University, USA. Jed worked for a year at the Energy Institute at Johannes Kepler University as a project associate. He continues to collaborate with European colleagues on research projects relating to the de-carbonization and associated restructuring of the European electricity grid. Jed specializes in econometric techniques applying them to a wide range of contexts in economics including: energy, forestry, environment, and climate change. Jed has authored numerous noteworthy publications in his short career including contributions to leading energy and environmental economic journals. Jed also received the 2013 award for Outstanding Master’s Thesis from the national Agricultural and Applied Economics Association for his work on the economic impact of forest pests. Jed hopes to continue his research into energy and environmental issues with a focus on the impact of climate change to aid in the global movement toward low carbon energy systems.



## Willis Towers Watson and Willis Re

Willis Towers Watson is a leading global advisory, broking and solutions company that helps clients around the world turn risk into a path for growth. With roots dating to 1828, Willis Towers Watson has 39,000 employees in more than 120 countries. It designs and delivers solutions that manage risk, optimize benefits, cultivate talent, and expands the power of capital to protect and strengthen institutions and individuals. Corporate Risk and Broking (CRB) provides a broad range of risk advice and insurance broking services to clients ranging from small businesses to multinational corporations. The mission is to help clients to become more resilient in an increasingly complex and risky world, so that they can secure their existing business and develop new ones. Willis Re is one of the world's leading reinsurance advisors and a member of the newly merged Willis Towers Watson serving 80% of the world's 1,000 largest companies. Its core focus is to provide a comprehensive suite of solutions to help clients manage, analyze and measure risk and capital – through investment advice, advanced analytics, structuring and completing transactions, issuing securities and placing risk, to identify and quantify sources of risk, and how they interrelate, using a wide range of innovative analytical tools and techniques. The tools includes a complete set of commercial models supported by our own proprietary models providing additional insight. The Willis Research Network further supports our risk quantification through open academic research and the development of new risk models and applications. The ethos of the Willis Research Network is to provide an open forum for the advancement of the science of extreme events – creating close collaboration between universities, insurers, reinsurers, catastrophe modeling companies, government research institutions and non-governmental organizations.



### Marc Lehmann

Marc Lehmann joined Willis Towers Watson in October 2008 as founding member of the Strategic Risk Consulting team in London. His primary responsibility is to coordinate, manage and deliver a wide range of natural hazard risk consulting services (including catastrophe modelling and risk engineering assessments) for the Willis global corporate client base. The list of clients Marc has worked for, both at Willis and in previous positions includes some of the major public, commercial and industrial organizations around the world. Prior to Willis Marc was Principal and Business Development Director for the global engineering firm ABS Consulting (formerly EQE International), where his responsibilities included the undertaking and management of various Natural and Man-Made Hazard risk management assignments for industrial clients such as conducting property surveys for earthquake, storm and flood hazards to assist clients in their risk transfer decisions, as well as identifying and implementing risk mitigation solutions. Marc's earlier experience included working a senior structural design engineer on a number of international construction projects for companies such as Ove Arup & Partners, Battle McCarthy, Systra and Calatrava Valls. Marc holds engineering degrees from the Swiss Federal Institute of Technology (ETH), Zurich and Imperial College, London and is fluent in English, French and German.



## Torolf Hamm

Torolf Hamm joined Willis Towers Watson in 2011 and now leads the Natural Catastrophe Strategic Risk Management Consulting team in London. His primary responsibility is to manage natural and man-made hazard risk consulting projects (including catastrophe modelling and risk engineering assessments) for large global organisations. Torolf has a strong track record of delivering risk financing and risk mitigation projects across all sectors, including energy and oil & gas companies. Prior to Willis Towers Watson, Torolf worked as Senior Catastrophe Modeller and Technical Lead Vulnerability Engineer for Risk Management Solutions (RMS), where he was responsible for the development of the vulnerability and building inventory model for the RMS UK'08 Flood Model and the upcoming RMS Euro Flood Extension Model. He led and participated in various Catastrophe Response Missions that included the 2007 Kent Earthquake, June 2007 UK Summer Inland Floods and the July 2009 Inland Floods in Austria. While at RMS Torolf also was strongly involved in the development of the RMS Euro Windstorm '11 Inventory and Industry Exposure Model (IED). Torolf's earlier experience included working as a Principle Buildings Materials Consultant on a number of high profile projects, in some cases as expert witness for STATS Limited (now RSK STATS Limited). Torolf holds a PhD in Engineering Geology from Imperial College and a German Diploma in Geology (Dipl.Geol) from the RWTH Aachen.



## Brigitte Balthasar

Brigitte joined Willis Re Analytics in 2009 as a catastrophe risk analyst. Working in different regional teams such as Japan, Latin America and Europe as well as locations (London, Washington D.C. and Paris) she has 7 years of catastrophe modelling experience and is leading the Catastrophe Management Services team for Germany, Austria and Switzerland since 2011. She is currently based in Munich, Germany. In her current position, her primary responsibility is to coordinate, manage and deliver a wide range of catastrophe risk consulting services for the Willis Re client base in Germany, Austria and Switzerland. Moreover she engages in the Willis Research Network in the field of global risk assessments and climate change mitigation. Relatedly, she conducted her secondment with the United Nations International Strategy for Disaster Reduction (UNISDR) in Geneva in early 2011. In her role as a consultant she co-authored the Global Assessment Report of disaster risk reduction and developed recommendations for its further development. Before joining Willis, Brigitte was a high school teacher instructing mathematics and geography in Germany, and acquired a certification in bilingual education. She conducted her studies at the Universidad de Zaragoza (Spain) and the Albert-Ludwigs-University Freiburg (Germany). The latter awarded her MSc degrees in geography, mathematics and instructional design. She is fluent in English and German.



**Organization for Security and  
Co-operation in Europe (OSCE)**

Wallnerstrasse 6  
A-1010 Vienna, Austria  
Tel.: +43 1 514 360

info@osce.org  
www.osce.org

 [facebook.com/osce.org](https://facebook.com/osce.org)

 [@osce](https://twitter.com/osce)

 [youtube.com/osce](https://youtube.com/osce)

# Protecting Electricity Networks from Natural Hazards